

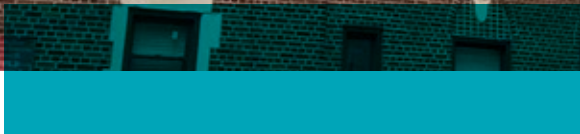

ROCKWOOL Smartrock® Existing Masonry Wall

Installation Instructions



Introduction

This document provides installation instructions for ROCKWOOL Smartrock and related products. The guidelines and examples included are generally applicable across North America. However, because of the variability in design, materials, environmental conditions, and existing substrates, specific applications require an independent assessment by experienced professionals, such as the Project Architect, Engineer, and/or Contractor. These professionals must use their judgment to determine the suitability of the proposed products and installation strategy for each unique project.

Setup Procedure:

Assess the existing masonry substrate to determine whether interior continuous insulation can be added without creating undesirable conditions that may impact the durability of the wall assembly and structure.

Substrate Preparation:

Clean the substrate by removing loose materials, debris, dust and other matter that would prohibit proper installation. Any vapor-impermeable coating or paint should be removed.



Responsibility:

Design team and contractor should follow all product installation instructions and are responsible for materials and make up of the wall assembly, including proper detailing for each of the control layers.

Equipment/Tools:

- OSHA required PPE (i.e. gloves, safety glasses, dust masks, ear protection, etc.)
- Serrated insulation knife
- Framing square
- Drill with bits to match insulation fastener/attachment requirements
- Hammer
- Airless sprayer, paint brush, or roller for liquid applied air barrier
- 20 oz. caulking gun
- Depth gauge

Note: The substrate onto which the liquid-applied air barrier, adhesive and/or tape is applied should be dry, smooth, and free of dust, silicone, grease, and other water repellent substances. When in doubt, verify suitability of substrate with an adhesion test.

To view video walk-through of installation instructions, visit rockwool.com/smartrock

Installation Contents

Section A: Wall Applications

Installation Components	Pg. 4
Fastener Recommendations	Pg. 5
Airsealing Quantities	Pg 5
Taping Application Guidelines	Pg 5
1 Prepare Substrate	Pg. 6
2 Apply Liquid Applied Membrane	Pg. 6
3 Penetrations - Sealing At Face Of Substrate.....	Pg. 6
4 Cutting ROCKWOOL Smartrock.....	Pg. 7
4.1A Begin Smartrock Insulation Install (Plastic Washers)	Pg. 7
4.1B Secure Smartrock to Substrate (Plastic Washers)	Pg. 7
4.2A Begin Smartrock Insulation Install (Installation Pins)	Pg. 8
4.2B Secure Smartrock to Substrate (Installation Pins).....	Pg. 8
4.3A Begin Smartrock Insulation Install (Screw&Washer)	Pg. 8
4.3B Secure Smartrock to Substrate (Screw&Washer).....	Pg. 9
5 Airseal Anchors	Pg. 9
6 Airseal Seams Between Boards.....	Pg. 9
7 Repairing Damaged Membrains or Replacing Boards	Pg. 10
8 Airseal at Floor Line	Pg. 10
9 Penetrations Sealing at Face of Smartrock	Pg. 10

Section B: Wall and Ceiling Transitions

1.1 Wall / Floor Joints	Pg. 11
1.2 Wall Transition to Interior/Party Wall.....	Pg. 11
2 Sealing Boards to Floor Joists.....	Pg. 12

Section C: Window Application

1.1 Window Penetration: Window Buck	Pg. 13
---	--------

Section D: Interior Finish

1 Uninsulated Service Cavity.....	Pg. 18
2 Insulated Service Cavity	Pg. 18

ROCKWOOL Smartrock



This product combines the installation of insulation and an integrated smart vapor retarder layer (Pro Clima INTELLO® PLUS) into a single step, which also acts as a secondary air control layer when appropriately detailed for continuity (per these application instructions). ROCKWOOL Smartrock also offers a Class-A fire rating per ASTM E84, and reliable long-term thermal performance.

Air Sealing Components



VISCONN / VISCONN FIBRE

High-quality, liquid-applied vapor permeable air barrier. Apply with airless sprayer, paint brush, or roller onto brick, CMU, concrete, wood framing, joist bays, WRBs and all Pro Clima membranes. The acrylic membrane forms a seamless, elastic air barrier once cured. Available in white (dries white) or blue (dries black).



TESCON® VANA

Multipurpose interior and exterior vapor semi-permeable tape (8 perm), designed to permanently seal membranes, plywood, OSB, concrete, and ROCKWOOL Smartrock. TESCON® VANA is available in the following widths: 2-3/8", 3", 4", 6", and 8".



CONTEGA® SOLIDO IQ

Versatile, high-performance flashing and air sealing tape with smart vapor-retarding properties. Its flexibility and vapor control properties make it ideal for sealing window frames and openings to the air barrier. Its modified acrylic adhesive can be applied to most concrete and masonry without the need for a primer. Available in 3-1/8", 6", and 12".



KAFLEX / ROFLEX

EPDM gaskets are available for quick, flush, adjustable, and durable air sealing of wires (KAFLEX) and pipes (ROFLEX). The pre-formed gaskets are sized to seal penetrations with a diameter ranging from 1/4" to 8-3/4".

For all components used during installation, including those not mentioned in the previous pages, always review manufacturer's installation instructions prior to starting work.

Insulation Attachment Options:



Trufast Plasti-Grip PMF Anchors



Trufast Thermal-Grip Insulation Pins



Trufast Thermal-Grip Prong Washers & Self-Drilling Screws

Secure the ROCKWOOL Smartrock insulation boards to the substrate using an approved installation method.

Depending on the condition of the existing substrate, available tools and equipment, and installer training, there are several options for installation of ROCKWOOL Smartrock. PMF anchors and Thermal-Grip washers require pre-drilling into the substrate, while the insulation pin system, when suitable, provides improved efficiency by expediting speed of install.

Contact ROCKWOOL or 475 High Performance Building Supply for additional information including alternative manufacturer solutions.

Trufast Video Link:
trufastwalls.com/videos

Hand Tools:



PRESSFIX

Tape application tool made from flexible plastic used to provide sufficient and uniform pressure to get the optimum bond between the Pro Clima tape and a substrate.



SERRATED INSULATION KNIFE

ROCKWOOL Smartrock is easy to cut around windows, doors, outlets, piping and other details or penetrations. A serrated insulation knife should be used to achieve a sharp and even cut of the product when required. Replace blades periodically as they tend to dull with use.

Always follow OSHA, local, site and construction safety procedures.

ROCKWOOL Interior Insulated Mass Wall Application Guide: rockwool.com/mass_wall

Fastener Recommendations:

Mechanically attach ROCKWOOL Smartrock to the supporting substrate using a minimum of three (3) fasteners per full size 24" x 48" board using the below fastening pattern. See attachment guidelines below for more detail the attachment of full and cut board dimensions.

Project Architects and/or Engineers may adjust the number to meet specific conditions, design requirements, and/or recommendations from fastener manufacturers to obtain the desired performance. Fasteners must

be the appropriate type for the substrate, capable of withstanding applied pull-out resistance, and suitable for use in this application. Older masonry substrates on existing buildings can be brittle in some cases, requiring careful consideration of fastening methods to avoid excessive substrate damage.

When Smartrock insulation boards are required to be cut around penetrations, work with your project team to determine fastener guidelines for insulation securement.

ROCKWOOL Smartrock Attachment Guideline:

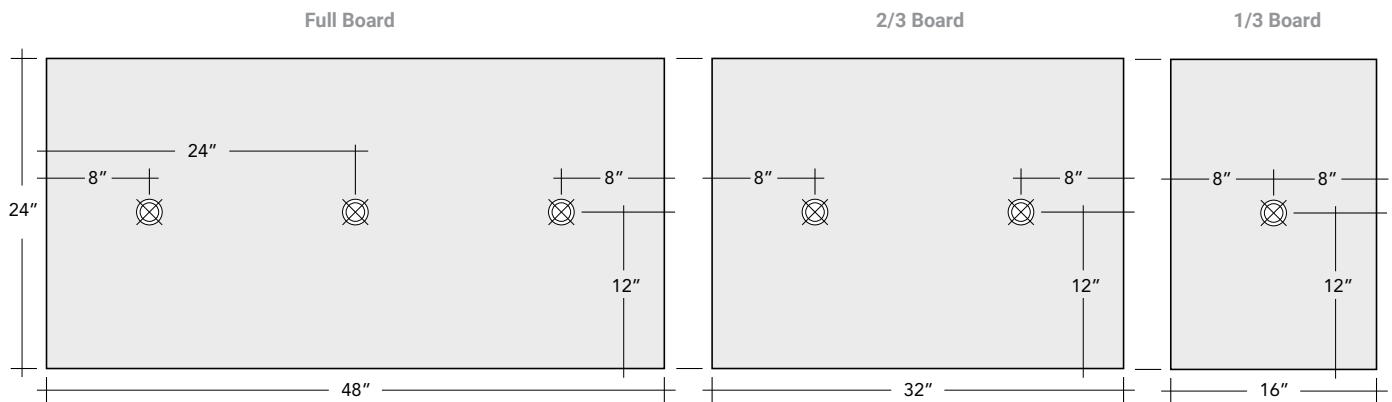

Airsealing Tape Quantities:

Ensure tape is pressurized using the Pressfix tool or an appropriate application tool, to apply firm and uniform pressure. Install the tape straight and flush with the substrate following the below minimum overlap guidelines.

The below table provides an estimate for the rolls of tape required for each pallet of ROCKWOOL Smartrock, based

Insulation Board Thickness	2"	2.5"	3"	3.5"	4"	5"
Est. # Tape Rolls / Pallet of Insulation	6	4.5	3.5	3	3	2.5

*Tape quantity may vary based on the geometry of the project

Tape Applications - General Guidance:

Avoid wrinkles and creases in the membrane and tape to mitigate the risk of pinholes which could impact the continuity of the secondary air control layer.

Taping to Substrates:

When adhering TESCON VANA to masonry or concrete substrates, VISCONN liquid-applied air barrier is required to promote adhesion.

CONTEGA SOLIDO IQ can be applied directly to masonry and concrete without the use of VISCONN.

Required minimum tape overlaps when air sealing two substrates. Ensure tape is applied using the Pressfix tool or a hand roller to apply firm and uniform pressure. Install tape straight and flush with the substrate following minimum overlap onto membrane.

- TESCON® VANA to ROCKWOOL Smartrock - 3/4" (20mm)
- TESCON® VANA to concrete with VISCONN - 1 1/2" (38mm)
- CONTEGA SOLIDO IQ to concrete - 1 1/2" (38mm)
- CONTEGA SOLIDO IQ to wood substrates - 3/4" (20mm)
- CONTEGA SOLIDO IQ to wooden/uPVC windows - 3/4" (20mm)

NOTE: The substrate onto which the adhesive and/or tape is applied should be load bearing, dry, smooth, and free of dust, silicone, grease, and other water repellent substances. When in doubt, verify suitability of substrate with an adhesion test.

Section A: Wall Applications

1 - Prepare Substrate

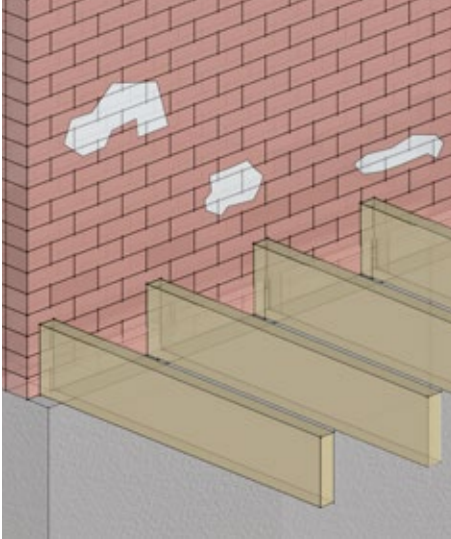

Clean the substrate using appropriate means and methods to remove dust, grease, silicon, dirt, etc. Remove any loose brick, mortar, concrete, etc. until the substrate is stable.

Fill larger holes as needed using mortar, plaster or VISCONN FIBRE to allow for a continuous air barrier membrane.

Project team to ensure that backup wall and building structural components are in adequate condition prior to moving forward with installation instructions.

[View VISCONN FIBRE datasheet](#)

2 - Apply Liquid Applied Membrane

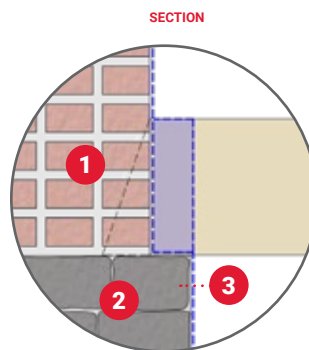
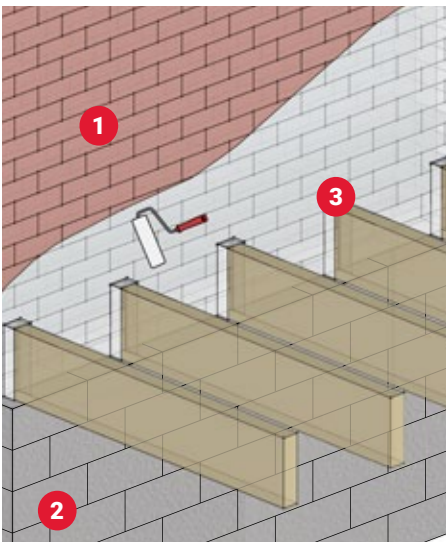

1. MASONRY
2. FOUNDATION WALL
3. VISCONN

Apply VISCONN to the substrate to serve as the primary air barrier. Ensure continuity of the air barrier across all wall areas including behind party walls (when possible).

Use a wet film thickness gauge to verify that 20 wet mils is applied. When applying to rougher substrates, backrolling VISCONN is recommended to ensure pinholes are sealed.

Allow VISCONN / VISCONN FIBRE to fully cure prior to moving forward with the subsequent steps.

[View VISCONN product page](#)

NOTE: The use of a liquid-applied membrane may not be required. Please work with your design team to determine requirements.

3 - Penetrations - Sealing at Face of Substrate / To Liquid-Applied Membrane



When encountering wall penetrations, the penetrations should be integrated with the air barrier through the use of tape and/ or EPDM connections such as ROFLEX or KAFLEX gaskets prior to installation of the ROCKWOOL Smartrock boards.

[View 475 High Performance Building Supply Blog Post: How to Seal Air Barrier Penetrations](#)

Section A: Wall Applications

4 - Cutting ROCKWOOL Smartrock



When installation requires you to cut ROCKWOOL Smartrock, place boards on a flat and rigid surface, with the membrane facing up. Maintain a minimum 1/2" space between the handle of the knife and the membrane to avoid puncturing.

Use a serrated insulation knife to create sharp and accurate cuts. Take extra care to cut slowly while maintaining a saw-like motion. Use a framing square to guide each cut.

If the membrane is punctured during the cutting, ensure damaged areas are properly sealed using TESCON® VANA tape, to maintain a continuous membrane.

View ROCKWOOL Guidelines for Cutting Stone Wool®

4.1A - Begin Smartrock Insulation Install (Plastic Washers)

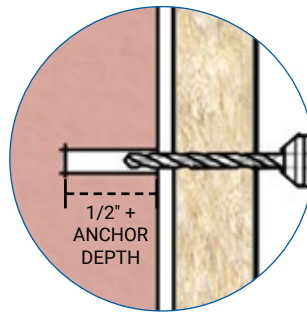
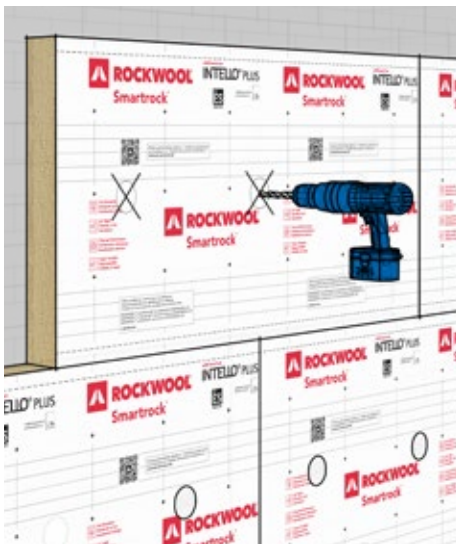

Install the ROCKWOOL Smartrock flush with the substrate and with boards tightly butted together, starting at the bottom of the wall and working upwards in a staggered/offset pattern.

When installing ROCKWOOL Smartrock using Trufast Plasti-Grip® PMF Anchors, start by predrilling through the insulation boards and into the masonry substrate, using a 5/16" masonry bit. Ensure that you drill into the substrate 1/2" deeper than the length of the anchor. Ream out any dust.

4.1B - Secure Smartrock to Substrate (Plastic Washers)

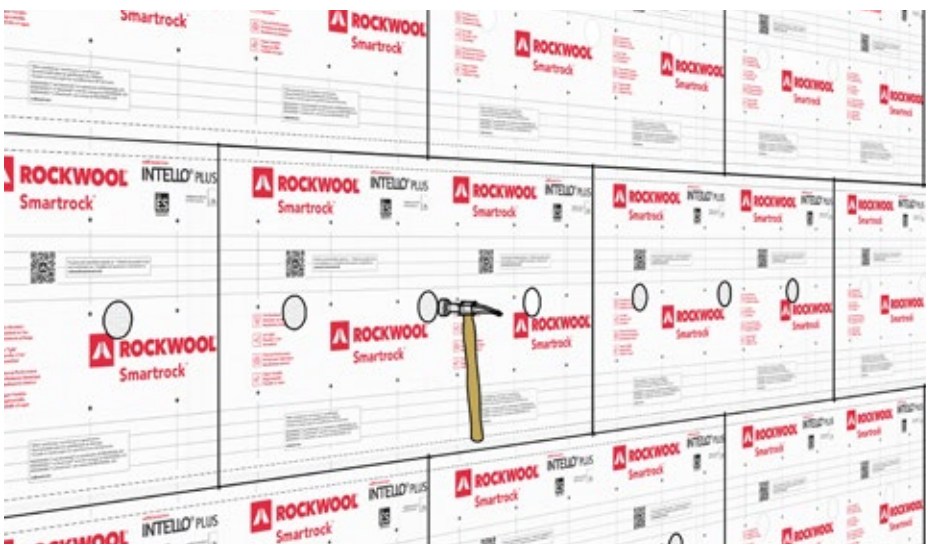

Finalize installation of the Trufast Plasti-Grip® PMF Anchors by tapping in the anchors using a hammer until flush with the insulation board.

Ensure that the anchors firmly secure the Smartrock boards to the wall substrate.

In the event the membrane is punctured, repair accordingly using TESCON VANA tape. If boards and/or membrane are damaged beyond repair, replace as needed. This is outlined in more detail in Step #7.

Section A: Wall Applications

4.2A - Begin Smartrock Insulation Install (Insulation Pins)

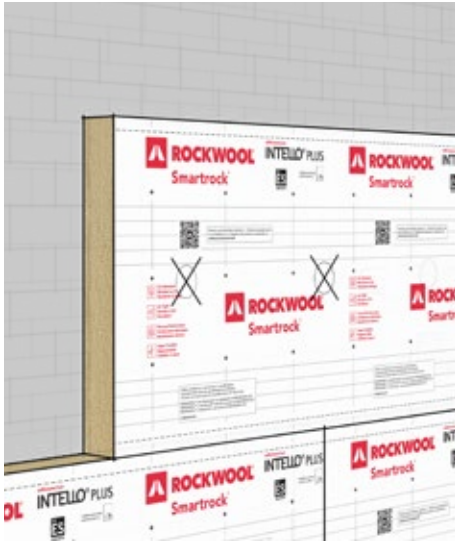

Install the ROCKWOOL Smartrock flush with the substrate and with boards tightly butted together, starting at the bottom of the wall and working upwards in a staggered/offset pattern.

For faster installation, pending the substrate meets required conditions, use shot-in Thermal-Grip Insulation Pins from Trufast.

With this fastening solution no pre-drilling is required. Start by using either the IP40 or IP50 and ensuring fuel cell and battery are properly inserted into the tool.

4.2B - Secure Smartrock to Substrate (Insulation Pins)

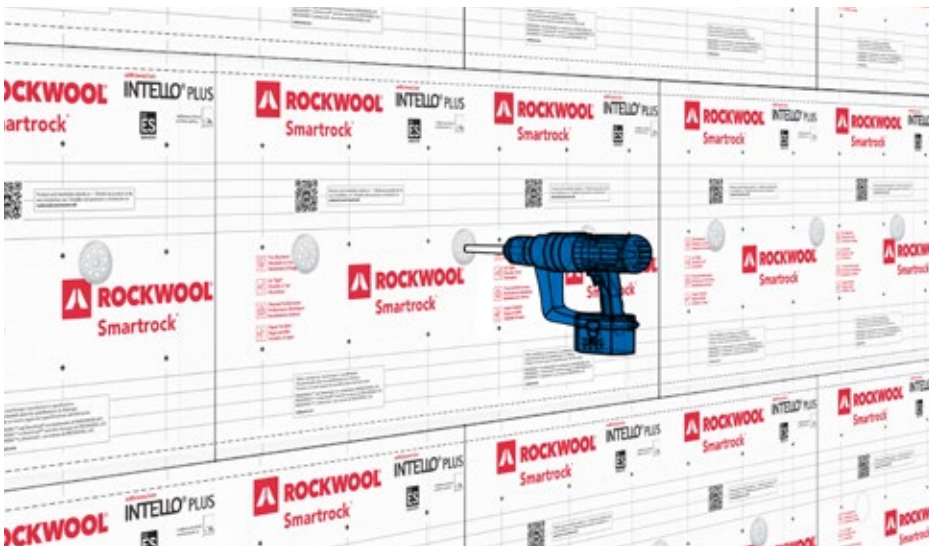

Secure ROCKWOOL Smartrock boards to the substrate by inserting the nose stem of either the IP40 or IP50 tool into the shank.

Press the fasteners into the insulation until the tip rests against the substrate and the safety has been released, then pull the trigger. Ensure that insulation pins are flush against the finished surface of the Smartrock boards.

In the event the membrane is punctured, repair accordingly using TESCON VANA tape. If boards and/or membrane are damaged beyond repair, replace as needed. This is outlined in more detail in Step #7.

4.3A - Begin Smartrock Insulation Install (Screws & Washers)

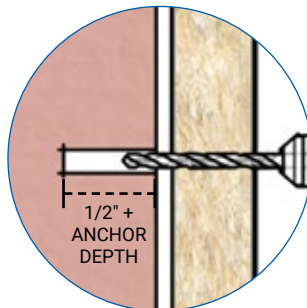
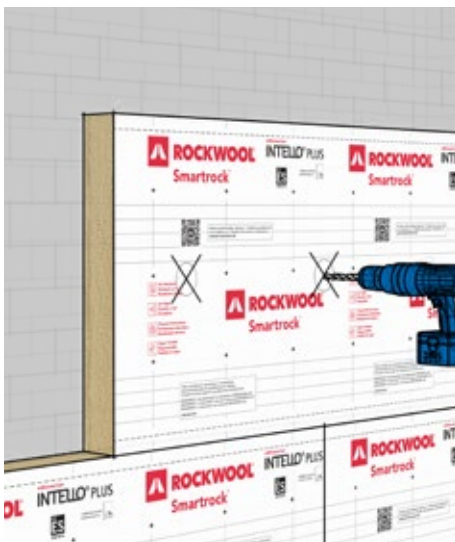

Install the ROCKWOOL Smartrock flush with the substrate and with boards tightly butted together, starting at the bottom of the wall and working upwards in a staggered/offset pattern.

Pre-drill the appropriate size hole through the insulation board and into the substrate 1/2" deeper than the length of the screw. Ream out any dust using the drill bit.

When installing ROCKWOOL Smartrock using Thermal-Grip ci Prong Washers, the dual prongs are designed to enable pre-spotting of the washer for easy on-the-wall screw assembly.

Section A: Wall Applications

4.3B - Secure Smartrock to Substrate (Screws & Washers)

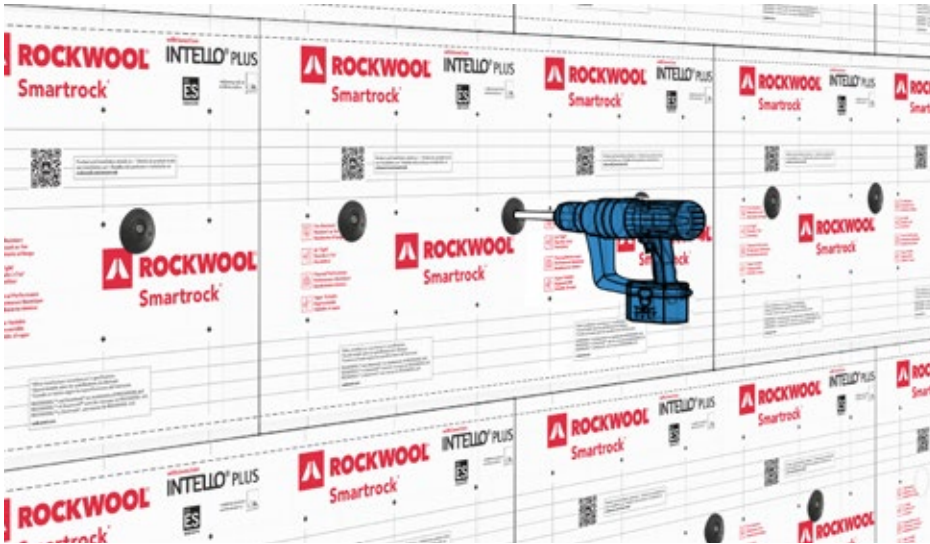

Finalize installation by pressing the washer onto the insulation and tightening the screw until snug to the surface of the insulation boards.

Ensure that washers are firmly securing Smartrock boards to the substrate without over compressing.

In the event the membrane is punctured, repair accordingly using TESCON® VANA tape. If boards and/or membrane are damaged beyond repair, replace as needed. This is outlined in more detail in Step #7.

5 - Airseal Anchors



Ensure that surfaces of the membrane are clean before applying the air sealing tape.

Airseal the anchor penetrations by applying TESCON® VANA tape centered on each anchor, and overlapping onto the membrane a minimum 3/4" on all sides as outlined on page #2 of this document. Press firmly to the Smartrock insulation boards using PRESSFIX.

6 - Airseal Seams Between Boards

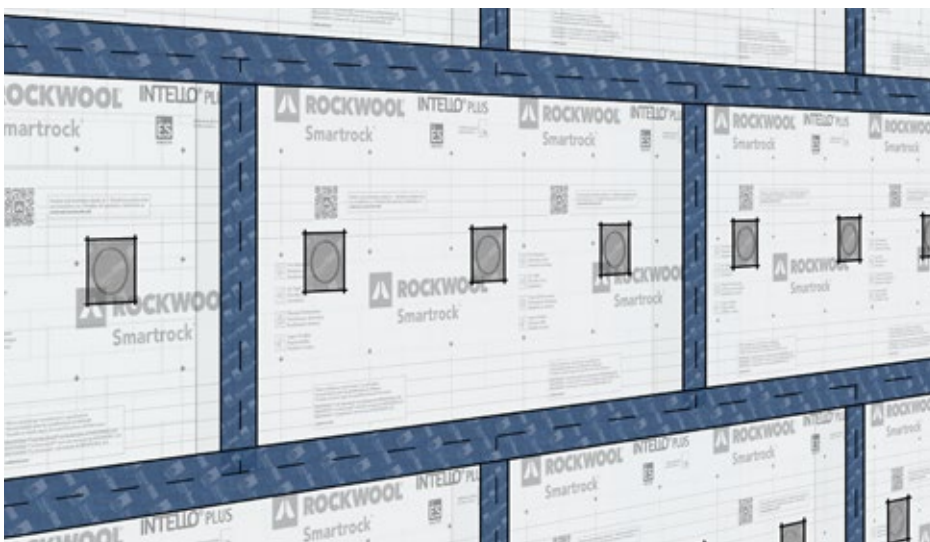

Tape the membrane joints with TESCON® VANA. Make sure to get at least 3/4" overlap onto the membrane of adjoining boards and at vertical/horizontal intersections.

Pressurize tapes using Pro Clima PRESSFIX. Avoid wrinkles and creases in the membrane and tape to ensure there are no pinholes which could impact the continuity of the membrane.

Section A: Wall Applications

7 - Repairing damaged membranes or replacing boards

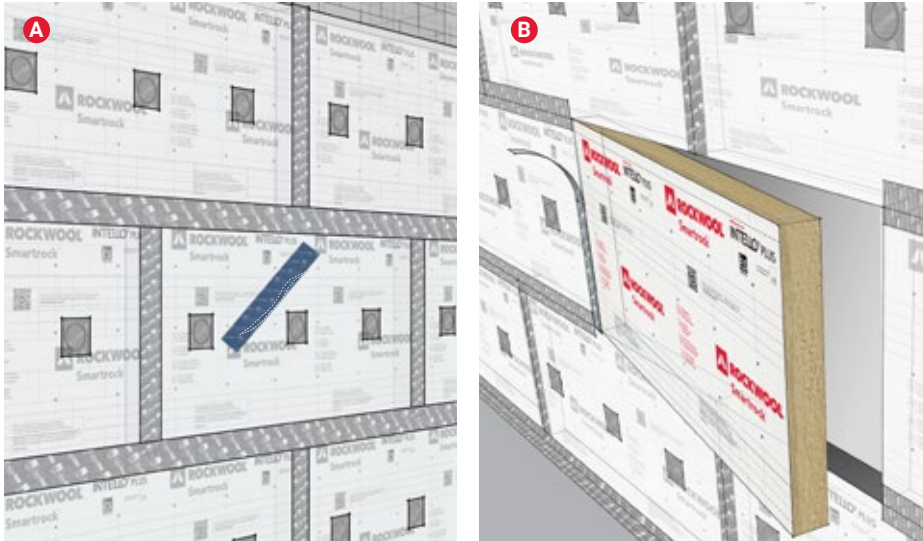

A. Repair damaged areas of the ROCKWOOL Smarttrack facer using TESCON VANA tape, ensuring a minimum 3/4" overlap onto the membrane on all side for proper air sealing.

B. For boards with excessive damage including larger tears, replace the entire insulation board by removing the fasteners and cutting back the tape as required. Once the new ROCKWOOL Smarttrack board has been installed, ensure air sealing is completed in accordance with these instructions.

8 - Airseal at floor line



At the base of the wall with a concrete floor, remove loose materials and sweep prior to taping the ROCKWOOL Smarttrack boards to the floor.

To ensure adhesion with the concrete surface, prime the concrete with VISCONN prior to adhering TESCON VANA tape. Alternatively, use CONTEGA SOLIDO IQ tape without a primer.

Follow the guidance provided on Page #2 for air sealing to a concrete substrate.

9 - Penetrations - sealing at face of Smarttrack



To ensure proper installation, cut the ROCKWOOL Smarttrack opening approximately the size of the penetration for a snug fit around the ROCKWOOL Smarttrack boards and apply TESCON VANA air sealing tape and/or Pro Clima gaskets to seal the penetration to the membrane surface of the ROCKWOOL Smarttrack facer.

[View 475 High Performance Building Supply Blog Post: How to Seal Air Barrier Penetrations!](#)

Section B: Wall and Ceiling Transitions

1.1 - Wall / Floor Joints

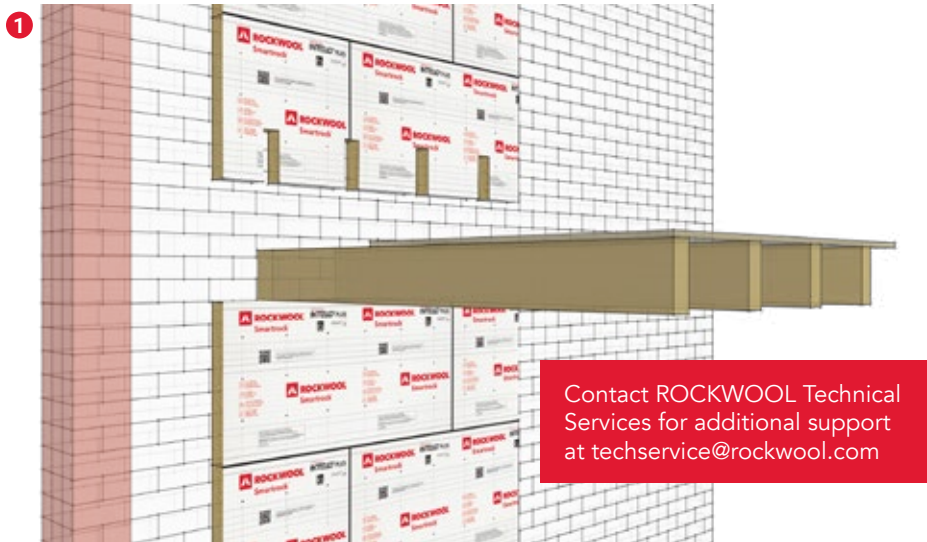

1. Cut ROCKWOOL Smartrock boards as required for installation around the joists at the floor line.

Cut the insulation boards using a serrated insulation knife, and use framing squares or other guides to make straight cuts, so Smartrock will fit tightly around joists.

If floor sheathing is removed, Smartrock can be installed from above. If floor sheathing remains in-place, the sheathing needs to be either cut back or integrated into the air barrier, prior to installing Smartrock from below.

Note: The condition of beam ends in masonry need to be assessed by the project engineer. If issues are outlined, those should be addressed before continuing with the installation.

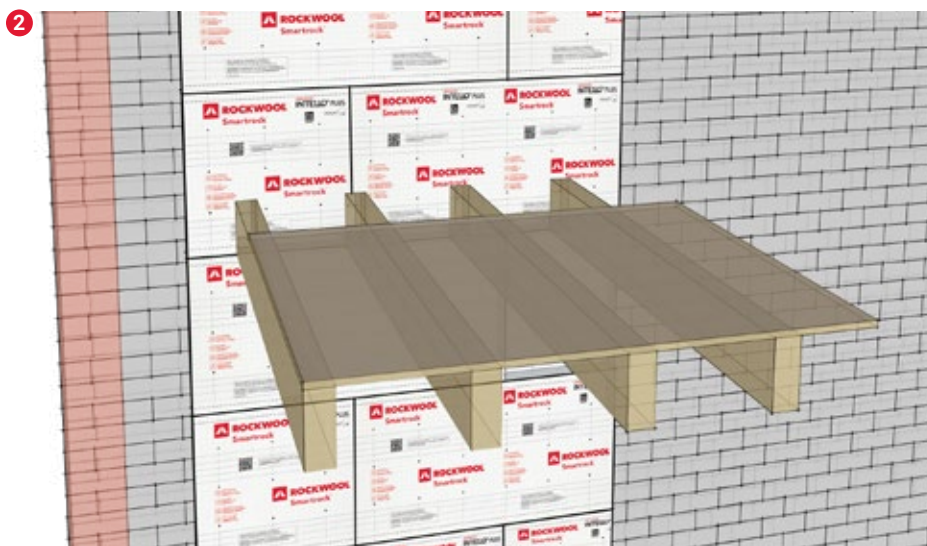

2. Once the bottom row of ROCKWOOL Smartrock boards has been installed around the joists, air seal the seams between the membrane on the boards and the joists (and floors if required) with CONTEGA SOLIDO IQ.

Use the narrow strip to adhere to the joists, and the wide strip of the tape to adhere to the membrane. Install the tape on all 4 sides of the joists as indicated on page 10, for a proper and complete airseal to the joist.

Follow guidelines for appropriate overlaps of tape to a wood substrate/framing.

1.2 - Wall Transition to Interior / Party Wall

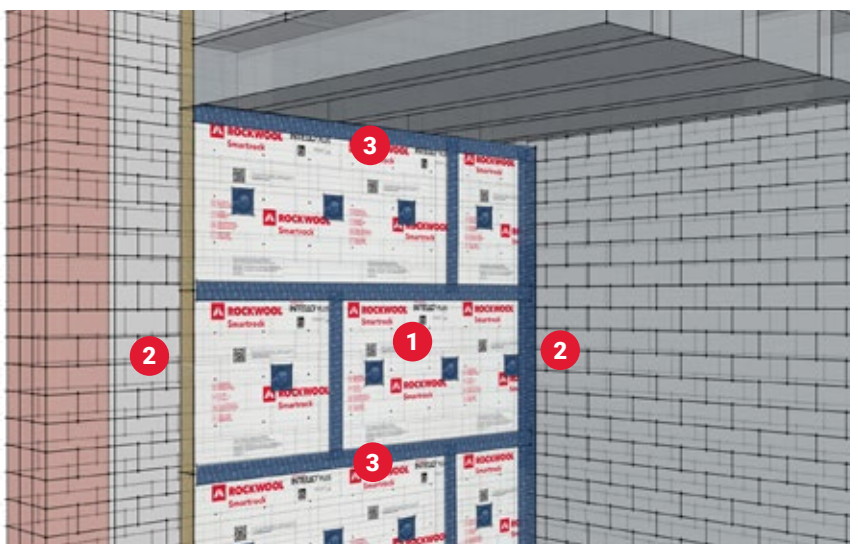

At corner transitions, butt the edges of the ROCKWOOL Smartrock board tight to the perpendicular walls. If the adjacent wall is an interior application make sure the substrate is airtight or is treated with VISCONN to become part of the airbarrier. Then airseal the connection between the Smartrock membrane and wall with TESCEN VANA tape.

Project team to coordinate termination of Smartrock at the roof-to-wall intersection, ensuring continuity of all control layers.

1. Smartrock
2. VISCONN
3. TASCAN VANA Tape

Section B: Wall and Ceiling Transitions

2 - Sealing Boards to Floor Joists

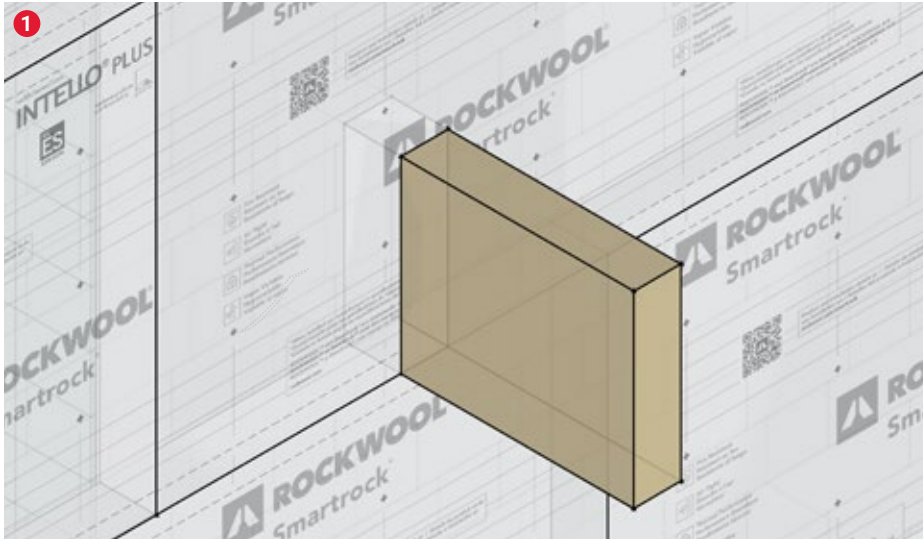

View [CONTEGA SOLIDO IQ product page](#)



1. Review condition of existing wood joists. Remove splinters and fill voids in wood checks as needed using VISCONN to allow for a continuous air barrier membrane.

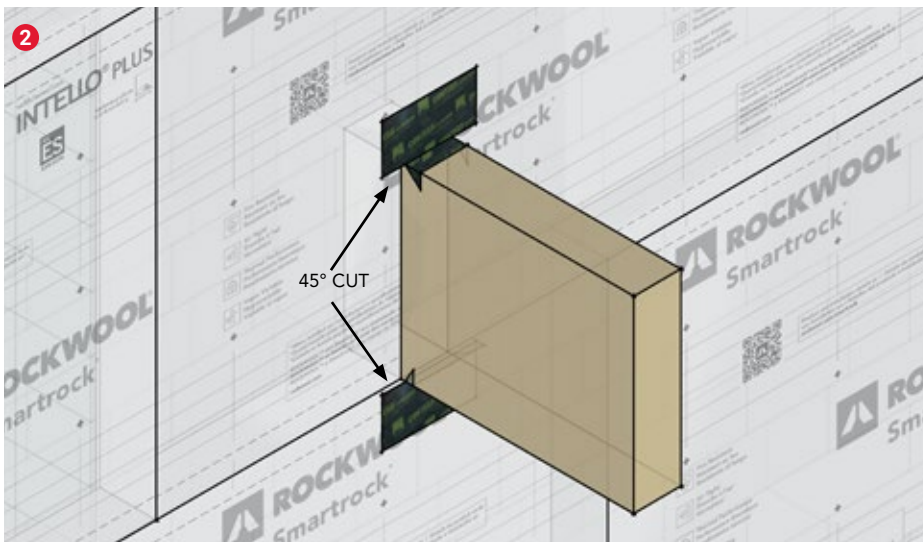

- 2A. Cut a piece of CONTEGA SOLIDO IQ tape that is the width of the joist plus an additional 4".
- 2B. Center the CONTEGA SOLIDO IQ on the top of the joist. Remove the release paper from the tape and apply it to the joist. Cut two slits at a 45° angle in the tape from the joist-to-Smartrock intersection on each side of the joists. Start the cut 1/8" from the intersection to ensure the tape prevents pinhole leakage.
- 2C. Remove the remaining release papers and adhere the tape on to the Smartrock membrane and on to the top of the joist. Activate the adhesive on the tape by applying firm and consistent pressure using PRESSFIX.
- 2D. Repeat the same process for the bottom of the joist.

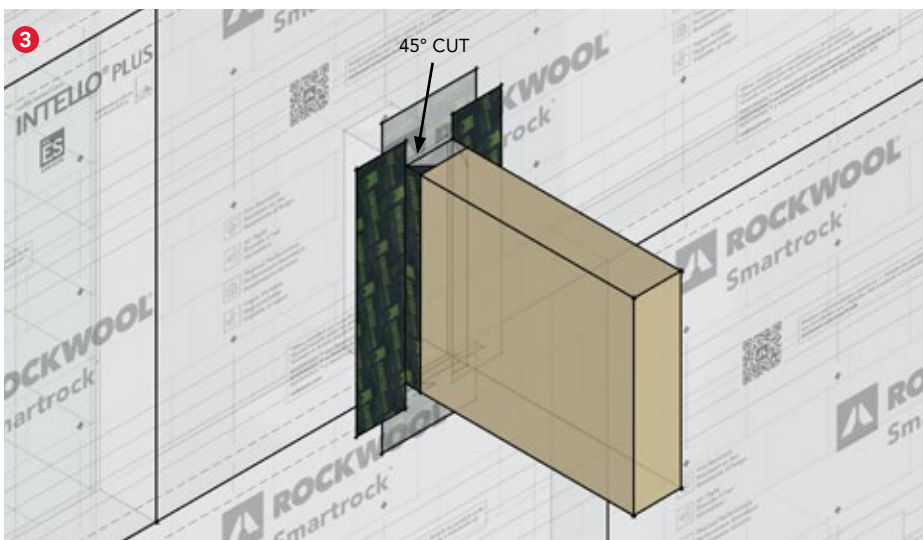

- 3A. Cut two pieces of CONTEGA SOLIDO IQ tape that is the height of the joist plus an additional 4".
- 3B. Center the CONTEGA SOLIDO IQ onto each side of the joist. Remove the release paper from the tape and apply it to the joist. Cut two slits at a 45° angle in the tape from the joist-to-Smartrock intersection on each side of the joists. Start the cut 1/8" from the intersection to ensure the tape prevents pinhole leakage.
- 3C. Remove the remaining release papers and adhere the tape on to the Smartrock membrane and to the sides of the joist. Activate the adhesive on the tape by applying firm and consistent pressure using PRESSFIX.

Section C: Window Application

1.0 - Window Penetration: Window Buck

Introduction to Window Detailing and Installation Instructions:

The following provides one example of window replacement and installation using high-performance windows. These instructions utilize installation of an interior window buck, designed to support contractors in achieving thermal and air barrier continuity while addressing moisture management at the window interface.

While this guide outlines one method, it is important to note that multiple window types and installation

scenarios exist, including retrofitting original windows during renovation projects. Each project may present unique challenges and requirements. As such, contractors are encouraged to collaborate with the project team, including architects, engineers, and the window manufacturer, to determine specific installation details and ensure compliance with local building codes, performance standards, and product specifications.

1

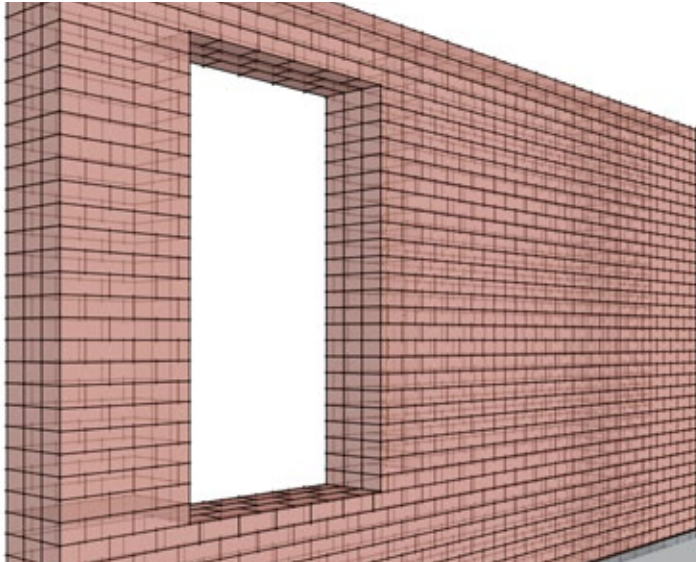

1. Prepare Rough Opening by cleaning the substrate, removing loose materials, debris and dust that impedes proper installation. Fill any voids or large cracks by pointing the bricks or parging the masonry with mortar, plaster, or VISCONN FIBRE.

2

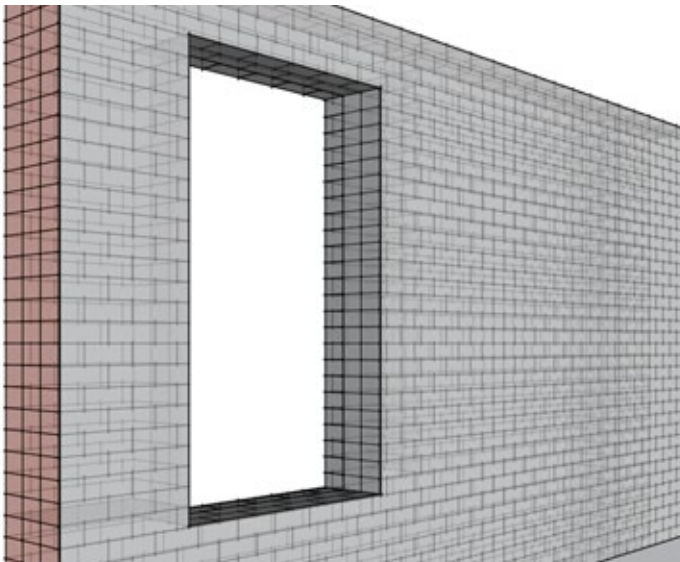

2. Apply VISCONN liquid applied membrane into the rough opening, at a thickness of 20 wet mils.

Extend VISCONN into the rough opening sufficiently past the depth of the window buck to allow for connection of the tape (to be added in Step #4) and liquid applied air barrier forming a continuous air control layer. Window buck dimensions should be determined by the project engineer / design team.

Section C: Window Application

1.0 - Window Penetration: Window Buck

3

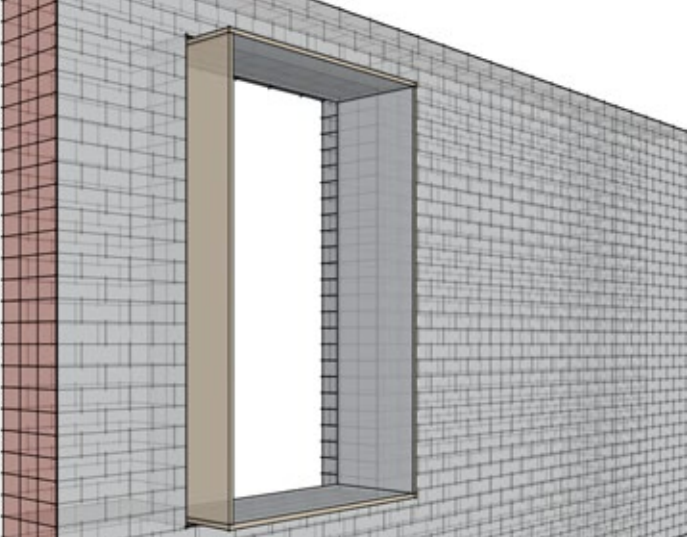

Exterior

Interior

- 3. Create and install a window buck made of sheathing material the size of the rough opening.

As a best practice, apply VISCONN liquid applied membrane onto the interior faces of the window buck, ensuring total coverage of 20 wet mil thickness. Once the liquid applied membrane is fully cured, secure the buck in place with appropriate fasteners, set in VISCONN.

The depth of the window buck should suffice to receive interior finishes as planned by designer.

4

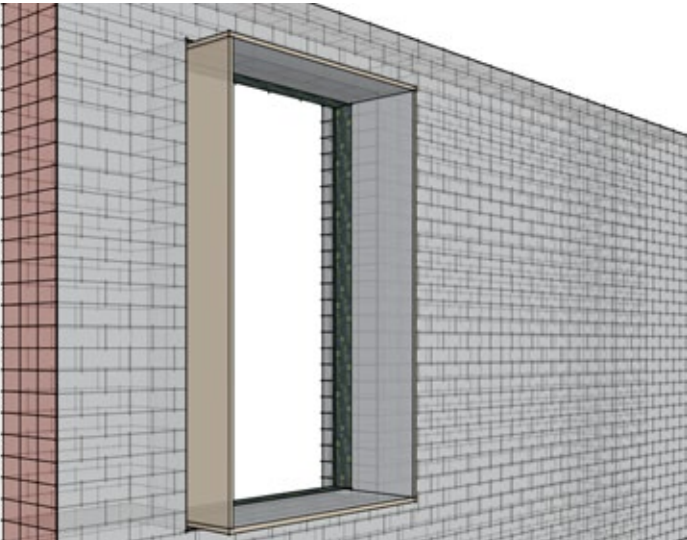

Exterior

Interior

- 4. Overlap CONTEGA SOLIDO IQ, tape from the window buck and onto the rough opening ensuring the tape is in contact with VISCONN liquid-applied air barrier, ensuring a minimum 1.5" overlap onto the surfaces of both the rough opening and the window buck.

5

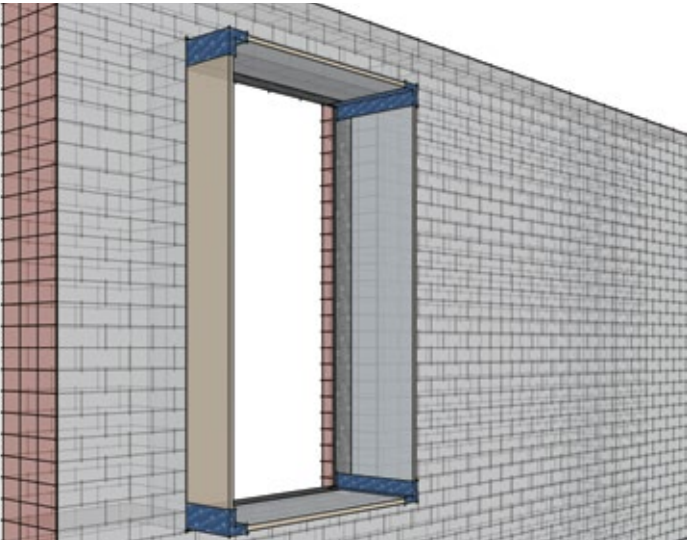

Exterior

Interior

- 5. Tape the inside corners of the plywood window buck using TESCON VANA tape.

Section C: Window Application

1.0 - Window Penetration: Window Buck

6



6. Install ROCKWOOL Smartrock boards, ensuring that the cut boards are tight against the window buck.

7

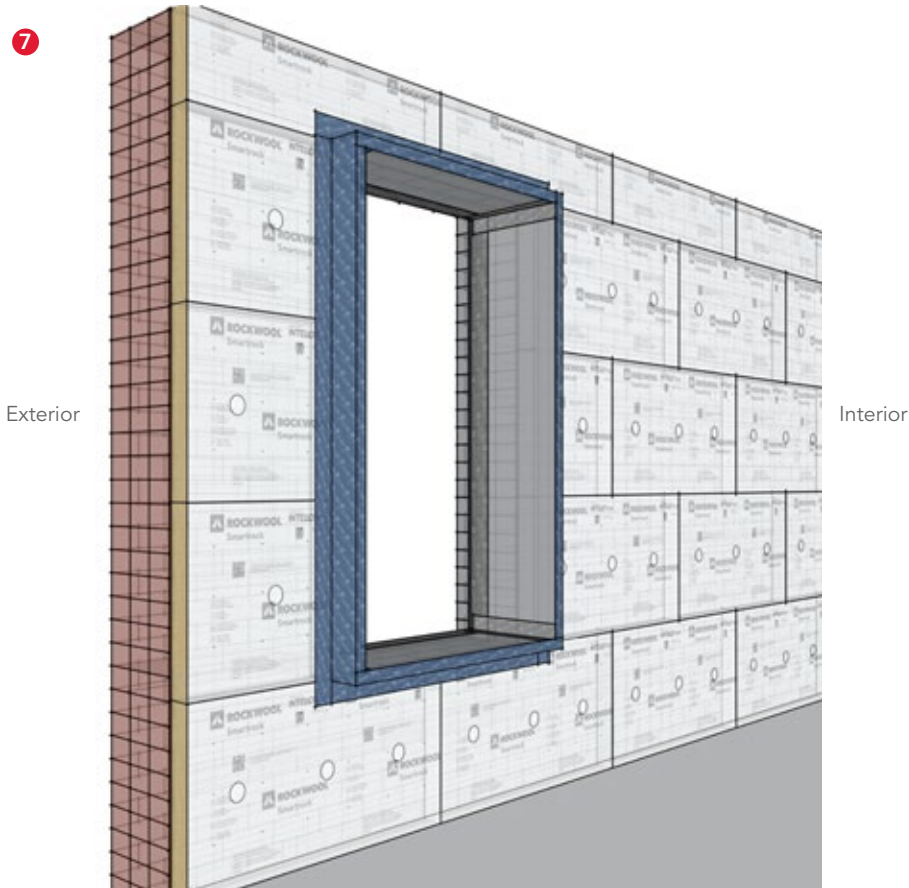

7. Tape Smartrock to the window buck. Wrap the buck on all sides with TESCON® VANA or CONTEGA SOLIDO IQ tape.

Section B: Wall and Ceiling Transitions

1.0 - Window Penetration: Window Buck

8

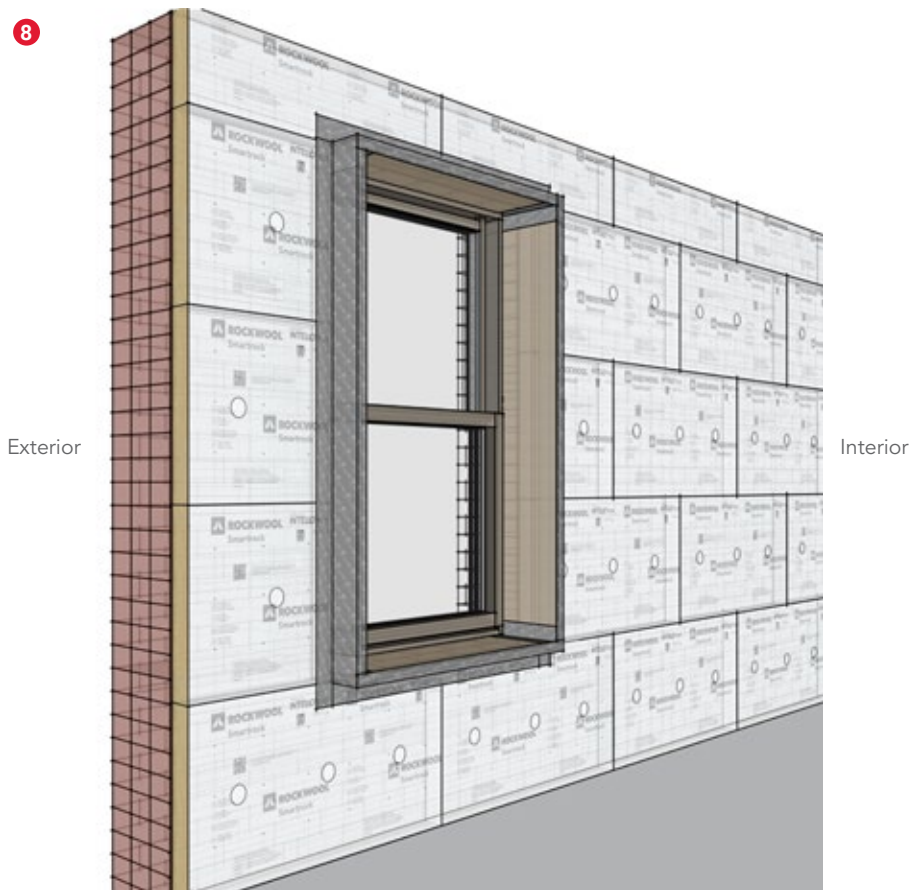

8. Install the window aligned with the ROCKWOOL Smartrock for thermal continuity.

Follow window manufacturer installation instructions for proper attachment of window within the window buck.

Example of a Typical Punched Window Jamb

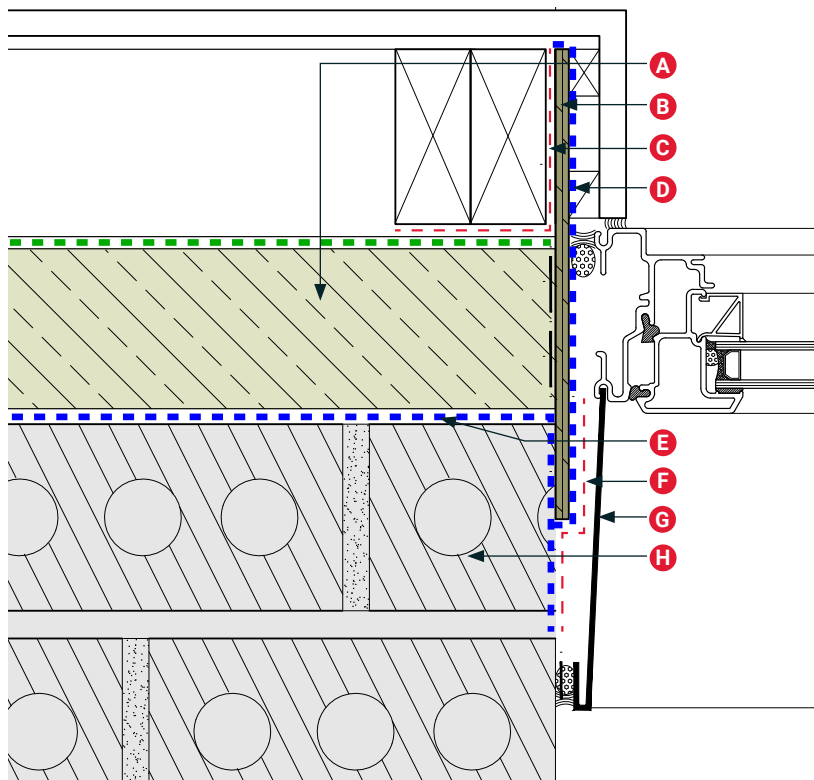

- A. Smartrock
- B. Window Buck
- C. Tescon Vana connecting Smartrock membrane to window buck
- D. Visconn on window buck
- E. Visconn on masonry wall and into rough opening
- F. Tescon Vana tape connecting window buck membrane and rough opening membrane
- G. Jamb flashing
- H. Masonry wall

Section B: Wall and Ceiling Transitions

1.0 - Window Penetration: Window Buck

9

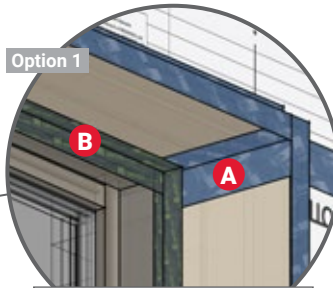
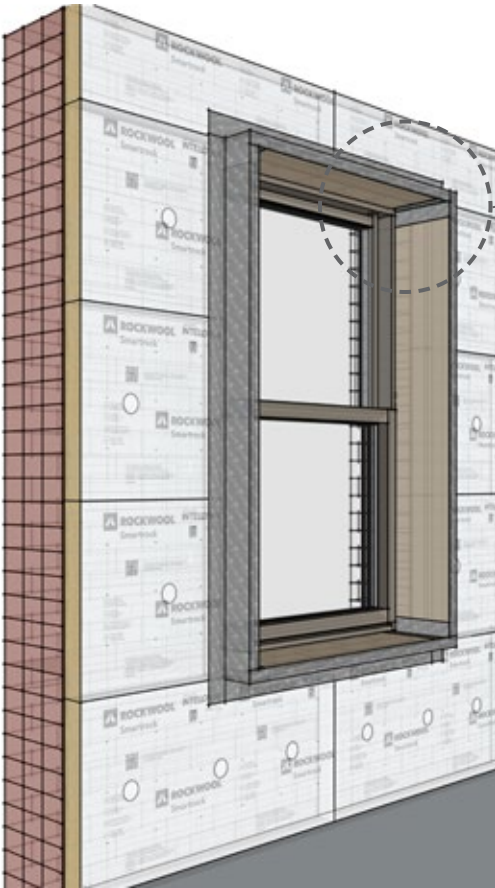

- A. TESCO® VANA Tape (Buck to Smartrock)
- B. CONTEGA SOLIDO IQ Tape (Window frame to Buck)

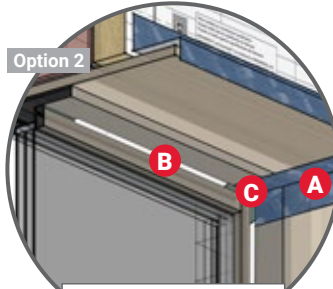

- A. TESCO VANA Tape (Buck to Smartrock)
- B. Sealant joint
- C. Backer rod

9. There are two solutions to achieve a durable, efficient, and high-performing connection between the window frame and the building envelope.

Option 1: Tape

Install CONTEGA SOLIDO IQ tape between the exterior face of the window and the rough opening as well as the interior face of the window and the window buck.

Option 2: Backer Rod & Sealant

Install a backer rod and sealant joint at the interior face of the window, between the window frame and the liquid applied air barrier surface of the window buck.

Flashing

Exterior flashing should be installed at the head and sill of the window ensuring adequate slope for drainage. Flashing can also be installed at the window jambs.

10

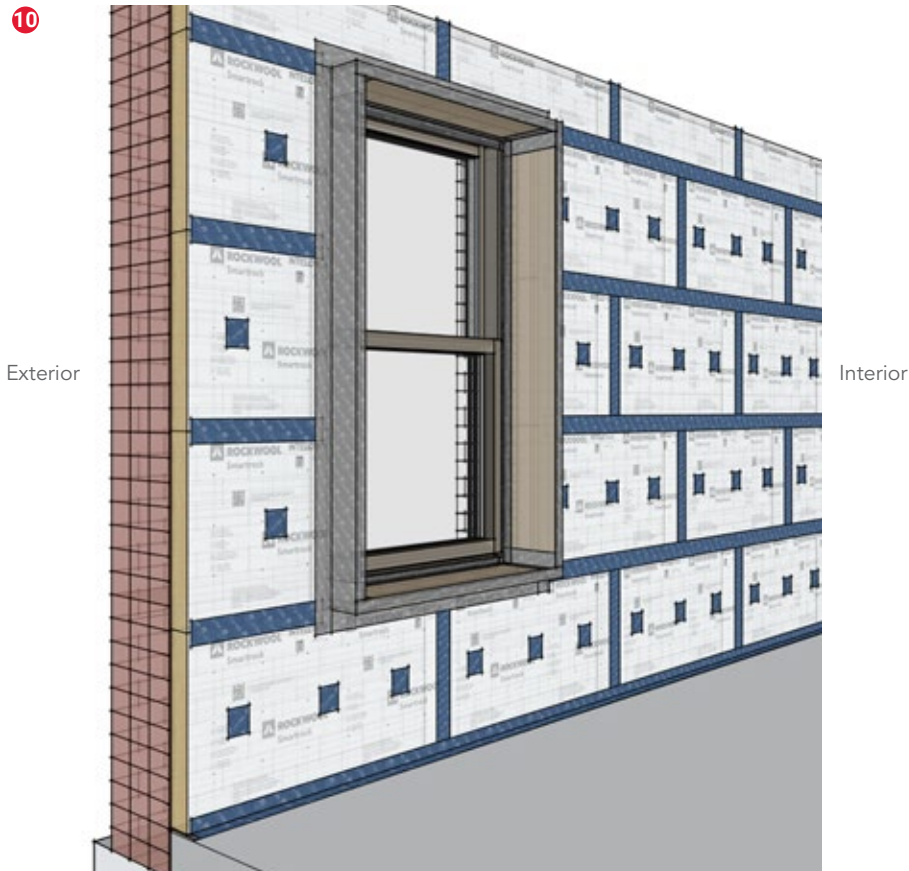

10. Tape ROCKWOOL Smartrock seams and anchors as per Section A on pages 7 and 8.

Section D: Interior Finish

It is important to recognize that interior insulation can alter the temperature profile and drying potential of a wall assembly. The appropriate amount of insulation for a particular building depends on several factors, including the condition of the existing substrate, its

exposure to moisture, and its vulnerability to freeze-thaw cycles. Therefore, each building must be independently evaluated using appropriate methods to develop a solution that mitigates these risks effectively.

1 - Uninsulated Service Cavity



Build and install a metal or wood stud service cavity. Install services as required (electrical, plumbing, HVAC) without damaging the Smartrock membrane and ProClima airsealing tapes. If the membrane is punctured, ensure the damaged areas are properly sealed using TESCON Vana tape.

Install interior finish as desired.

2 - Insulated Service Cavity



Build and install a metal or wood stud service cavity. Install services as required (electrical, plumbing, HVAC) without damaging the Smartrock membrane and ProClima airsealing tapes. If the membrane is punctured, ensure the damaged areas to properly sealed using TESCON VANA tape.

Install interior finish as desired.

The addition of batt insulation in the framing cavity may increase moisture-related issues. Site and climate specific analysis of the assembly should be performed prior to installation.

Disclaimer:

1. ROCKWOOL is a manufacturer and supplier of stone wool insulation products. 475.Supply are suppliers of air and vapor control materials. Neither ROCKWOOL nor 475.Supply has control over the final design, workmanship, necessary materials, or applicable conditions at a particular end use application installation site. These and other variables can impact both installation considerations as well as predicted performance

ROCKWOOL and 475 High Performance Building Supply disclaim any liability for the use of this document's content, whether liability is premised on contract, tort, or other legal theories. Users of these instructions assume full responsibility for evaluating and applying the information in their specific project contexts.

2. All recommendations made by ROCKWOOL and 475.Supply regarding installation, as well as predicted materials performance, including all calculations, drawings and other recommendations or information supplied by ROCKWOOL/475.Supply are therefore to be treated as information supplied by ROCKWOOL/475.Supply for general reference purposes only. The customer or installer is obliged to examine the information supplied by ROCKWOOL/475.Supply for its suitability for the specific installation and performance needs of the installation site. ROCKWOOL/475.Supply strongly recommends that the customer or installer retain a qualified expert or engineer with knowledge of the specific needs of the end use site where materials are to be installed.
3. ROCKWOOL/475.Supply makes no representation or warranty with respect to any of the information provided herein and is not liable for any direct or consequential loss or damage in any form and for any reason whatsoever arising from the advice and/or information referred to in this instruction or installation guide.

369 Warren St. Retrofit

Brooklyn, New York



A historic carriage house transformed into a modern office, focused on energy efficiency, durability, and sustainability while preserving the building's historic façade.

Product: Smartrock

Why ROCKWOOL: Thermal, vapor, air control, durability, efficiency

Building Type: Multi-story townhouse

[View full case study](#)

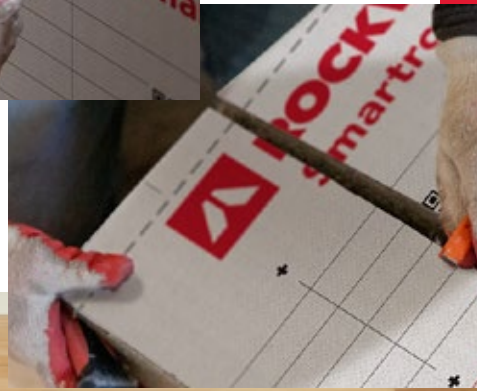

ROCKWOOL Group is the world leader in stone wool products, from building insulation to acoustic ceilings, external cladding systems to horticultural solutions, engineered fibers for industrial use to insulation for the process industry and marine & offshore. We are committed to enriching the lives of everyone who experiences our products and services, and to helping customers and communities tackle many of today's biggest sustainability and development challenges, including energy consumption, noise pollution, fire resilience, water scarcity, urban flooding, and more.

ROCKWOOL®, Rockfon®, Rockpanel®, Grodan®, and Lapinus® are registered trademarks of the ROCKWOOL Group.

Version 1 - April 2025



ROCKWOOL
8024 Esquesing Line
Milton, ON L9T 6W3
Tél: 1 800 265 6878
rockwool.com