

ROCKWOOL® FirePro®

Comprehensive range of passive fire protection
products and solutions







Contents

Page No.

Introducing ROCKWOOL FirePro

4

Fire stopping

Section 1 - Penetration seals / Core products	6
▪ FirePro 50mm Ablative Coated Batt	8
▪ FirePro 60mm Ablative Coated Batt	12
▪ FirePro Ablative Coating	16
▪ FirePro FireStop Compound	18
▪ FirePro High Strength FireStop Compound	22
▪ FirePro Intumescent Pillows CE	26
▪ FirePro Intumescent Putty Pads	30
▪ FirePro FireStop Pipe Collars CE	34
▪ FirePro Intumescent Pipe Wraps CE	38
▪ FirePro Insulated Fire Sleeves	42
▪ FirePro Intumescent Pipe Wrap Roll	46
▪ FirePro High Expansion Intumescent Sealant	50
▪ FirePro SpeedSeal	54
Section 2 - Cavity barriers & cavity firestops / Core products	58
▪ Fire Barrier System	60
▪ Fire Barrier Slab	76
▪ TCB & PWCB Cavity Barriers	80
▪ FirePro SP FireStop EN	84
Section 3 - Linear joint seals / Core products	90
▪ FirePro SoftSeal System Penetration Seals	92
▪ FirePro SoftSeal System Linear Joint Seals	95
▪ FirePro Linear & Trapezoidal FireStop System	98
▪ FirePro Acoustic Intumescent Sealant	104
▪ FirePro Silicone X	108
▪ SP FireStop OSCB	112

Fire protection

Section 1 - Structural steel / concrete / Core products	116
▪ Soffit Slab	118
▪ FirePro Glue	122
▪ FirePro BeamClad® Systems	126
▪ FirePro Fire Tube	132
FirePro BeamClad Fixing Guide	136
Section 2 - Building services / Core products	152
▪ RockLap H&V Pipe Sections	154
▪ FirePro DuctRock® Slab	164

ROCKWOOL Firestopping Principles

174

Legal disclaimer

176

Introducing ROCKWOOL FirePro

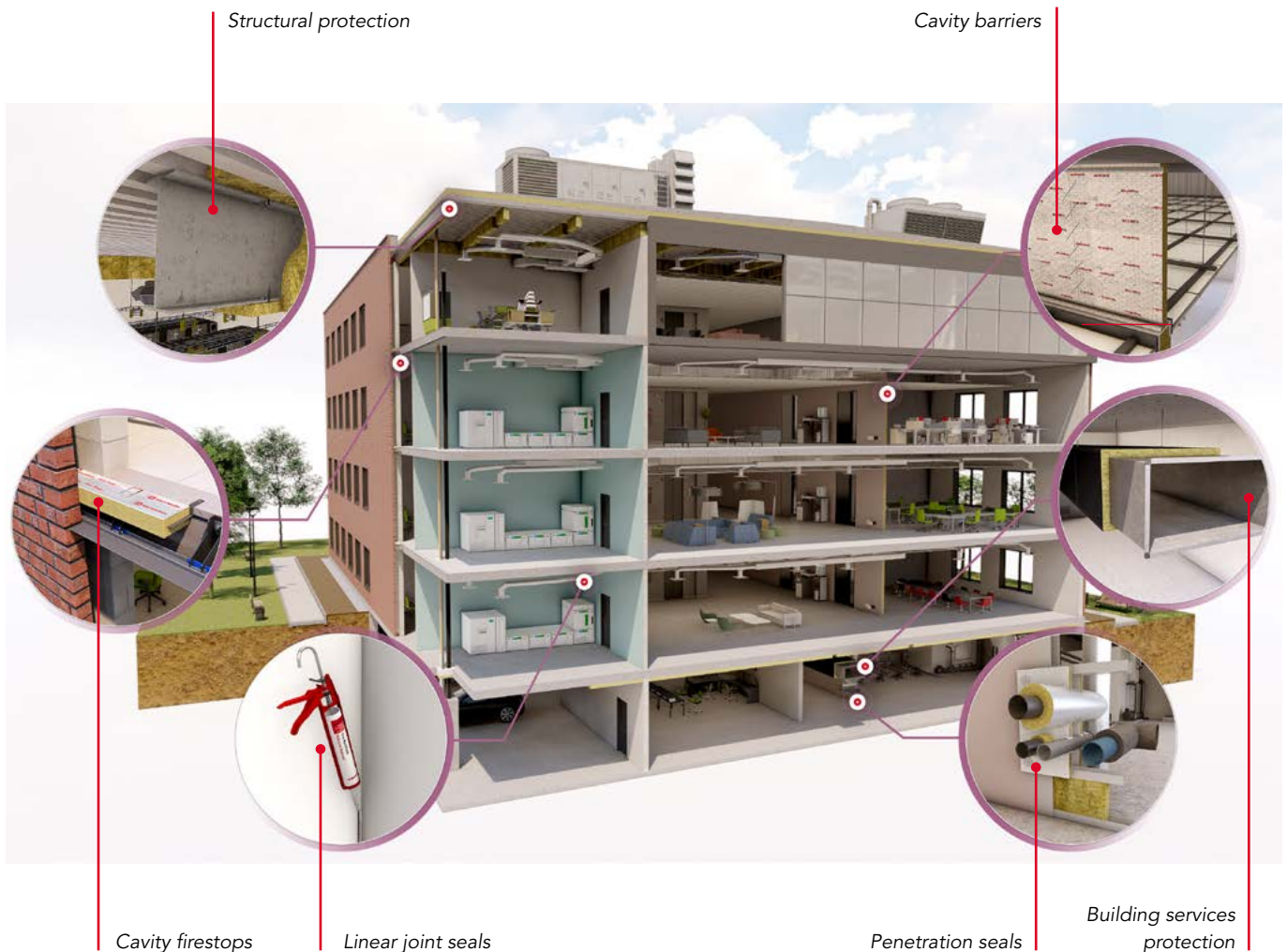
Passive fire protection is a critical component of any fire safety strategy.

Usually unseen but always at work, passive fire protection systems are built into the structure of the building to safeguard the lives of the building occupants. When properly installed, passive fire protection measures will protect the building's structure and limit the spread of fire and smoke by containing it within the compartment.

The ROCKWOOL FirePro range of passive fire protection products provides firestopping and fire resistance

throughout the building's construction, ensuring the building and its occupants are safer in the event of a fire. Our specialist range of products support architects, contractors and developers to conform to current building regulations.

In the ROCKWOOL FirePro Book you can find products for a range of specialist passive fire protection applications which include:



The ROCKWOOL FirePro Book is a comprehensive catalogue of tested and certified passive fire protection solutions.





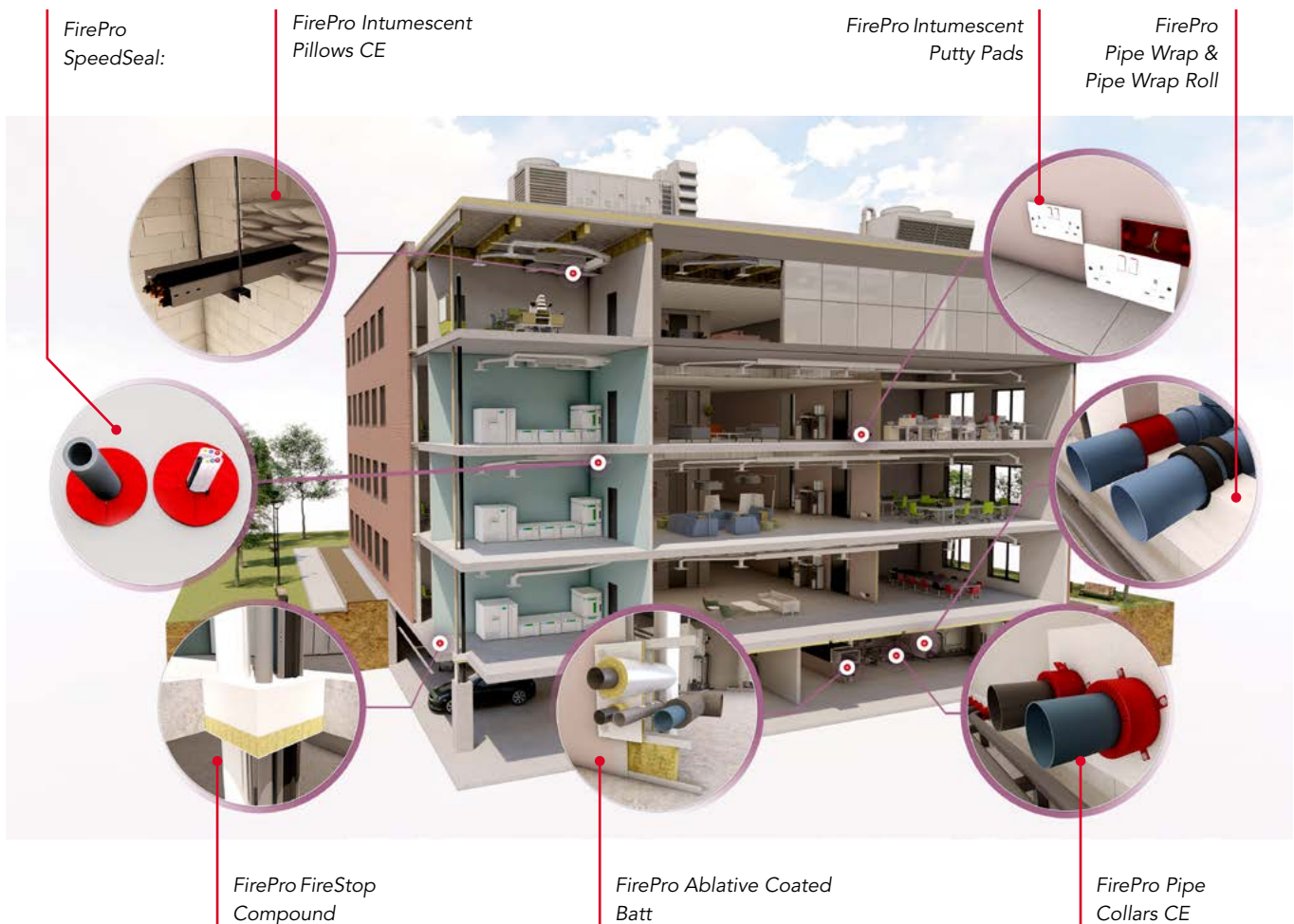
Section 1: Penetration seals

Modern buildings include a vast array of building services which when installed, often pass through fire resistant compartment elements. It is also important to consider that buildings are subject to change, and that many building services can be added throughout its lifetime.

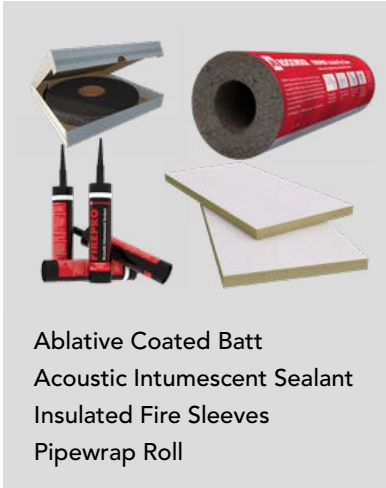
It is vitally important that breaches applied to compartment walls and floors by services are appropriately sealed to prevent the passage of fire and smoke. When sealing penetrations through compartment walls and floors, it is essential that approved and tested products are used to re-establish the fire resistance of the compartment.

ROCKWOOL Firestopping solutions include a wide range of 3rd party-approved products that have been developed to seal apertures made within compartment walls and floors. Within our range of penetration seals, we have products that have been designed for use with specific types of building services including:

- Combustible pipes
- Metal pipes
- Cables, cable trays & conduits
- Fire dampers
- Duct work
- Electrical sockets



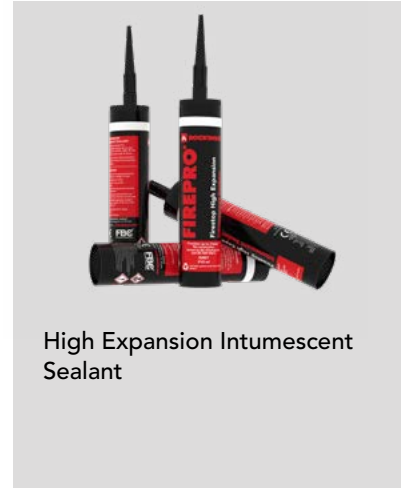
Core products



Ablative Coated Batt
Acoustic Intumescent Sealant
Insulated Fire Sleeves
Pipewrap Roll



FireStop Compound
High Strength FireStop Compound
Intumescent Pipe Wraps
FireStop Pipe Collar CE



High Expansion Intumescent Sealant



FirePro SpeedSeal



Intumescent Putty Pads



Intumescent Pillows

Useful documents and standards

ASFP Technical Guidance Document – TGD 17: Code of practice for the installation and inspection of fire stopping systems in buildings

ASFP Red Book: Fire stopping and penetration seals for the construction industry

ASFP: Ensuring best practice for passive fire protection in buildings

ASFP: On-site guide to installing fire stopping

[ROCKWOOL Firestopping Standard Details](#)

BS 476-20: Fire test on building materials and structures. Method for determination of the fire resistance of elements of construction

BS EN 1366-3: Fire resistance test for service installations. Penetration Seals

BS EN 1363-1: Fire resistance tests. General Requirements

BS EN 13501-2: Fire classification of construction products and building elements. Classification using test data from resistance to fire tests, excluding ventilation services.

ROCKWOOL guidance - HVAC specification detail guide

ASFP (Association for Specialist Fire Protection) guidance documents can be sourced at www.asfp.org.uk



FirePro 50mm Ablative Coated Batt

Fire stopping solution for voids in walls and floors



The ROCKWOOL Ablative Coated Batt comprises a high-density stone wool core, pre-coated on both sides with our high-performance ablative coating.

Ablative Coated Batt has been comprehensively tested as part of the ROCKWOOL FirePro range of fire protection products, specifically for use in service penetrations, head of wall and other void seals.

- Can provide fire resistance from a single thickness batt
- Comprehensively tested as part of the FirePro suite of solutions
- Suitable for sealing wall and floor voids containing most commonly used services and substrates
- Can be used as a blank seal and a head of wall seal
- Lightweight and simple to install
- Tested for air tightness, providing an additional smoke and acoustic seal

ROCKWOOL 50mm Ablative Coated Batt provides fire stopping solutions in walls and floors, reinstating the fire resistance.

50mm Ablative coated batt is also tested for acoustic and air leakage performance.

APPLICATIONS

- Multiple substrates including: solid walls and floors; flexible walls
- Multi-service penetrations
- Head of wall
- Blank seals
- Face-fixed applications
- Large-framed service voids

For a fully comprehensive list of applications, please refer to the appropriate ROCKWOOL standard details available at www.rockwool.com/uk or contact the ROCKWOOL Technical Solutions Team.

PERFORMANCE

Fire performance

Tests have proved the capability of a single 50mm Batt to provide up to 2 hours* fire resistance Integrity and Insulation ratings which are dependent upon the service penetrations and void size. Where 4 hours integrity and insulation are required we recommend the use of our 60mm Ablative Coated Batt. **Subject to the application*

50mm Ablative Coated Batt has been certified by UL and CE marked to EAD 350454-00-1104.

Use the links below to access further information on fire performance:

[UL-EU Certificate - UL-EU-01208-CPR >](#)

[ETA 22/0157 >](#)

[Certificate of constancy of performance - 2531-CPR-CXO10265 >](#)

[Fire Stopping Standard Details Guide >](#)

Acoustic performance

Tested for head of wall:

- Rw= up to 48db (2 x Coated batts)
- Rw= up to 37db (1 x Coated batts)

The correct use of Coated batt within concealed cavities and voids will reduce the level of transmitted sound:

- Rw= up to 52 db (2 x Coated batts) - incorporating 48mm O/D PVC /15mm copper pipe penetrations.
- Rw= up to 34 db (1x Coated batts) - incorporating 48mm O/D PVC /15mm copper pipe penetrations.

For specific acoustic requirements please contact ROCKWOOL Technical Solutions.

PRODUCT INFORMATION

Property	Description
Length	1200mm
Width	600mm
Thickness	50mm
Fire resistance	*Up to 2 hours
Density	160kg/m ³
Air leakage	0.8m ³ /h/m ²

**Subject to the application*

STANDARDS AND APPROVALS

Certificate
BS EN 1366-3: 2009 and the dedicated fire resistance standard for linear joint seals, BS EN 1366-4:2006. Ablative Coated Batt has been classified in accordance with BS EN 13501-2.
Third party certification through UL, Certificate No. UL-EU-01208-CPR. The certificate is available to download at www.rockwool.com/uk .
CE marked to EAD 350454-00-1104.



For further information on the full scope of fire performance please refer to the appropriate standard details available www.rockwool.com/uk or contact ROCKWOOL Technical Solutions.

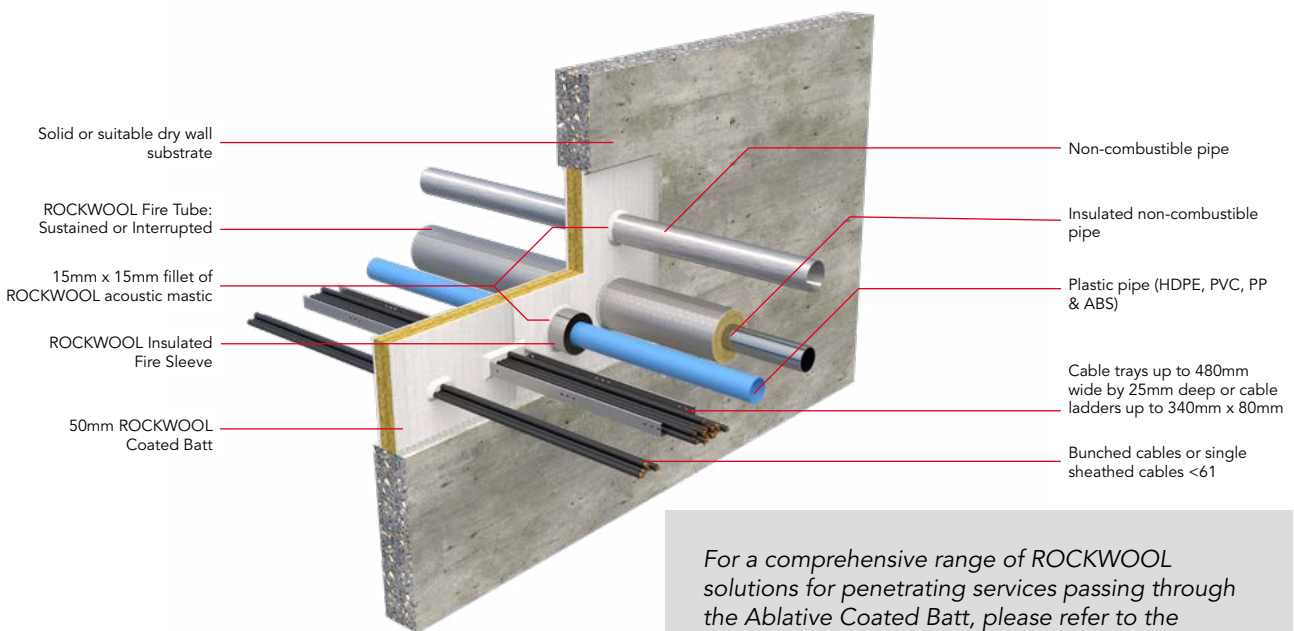
Important: All Ablative Coated Batt fire resistance tests were conducted using ROCKWOOL FirePro ancillary products as appropriate.



INSTALLATION

1. Make sure that the area within the aperture is clean of any debris and remove any dust from the edges.
2. Cut ROCKWOOL Ablative Coated Batt to the size and shape required to fit the aperture ensuring that batt will make a tight fit with all edges of the aperture.
3. Cut rectangular holes from the coated batt to accommodate cable trays or ladders containing cables.
4. Cut the Coated Batt across its width at the mid-point of each rectangular hole to enable the Batt to be fitted into the aperture.
5. Apply ROCKWOOL Acoustic Intumescent Sealant to all edges of the Batt ensuring that an even cover is achieved over the entire thickness of the Batt. This should include the outer edges of the Batt and the edges of the cuts made across the Batt to allow fitting into the aperture.
6. Insert the Batt into the aperture.
7. Apply a bead of ROCKWOOL Acoustic Intumescent Sealant approximately 15mm wide around the perimeter of the Batt ensuring that all gaps between the Batt and surrounding edges are fully filled.
8. Apply a bead of ROCKWOOL Acoustic Intumescent Sealant approximately 15mm wide where cables pass through the Batt. Ensure that the sealant fully enclosed each cable within the tray or ladder and that all gaps are fully filled.
9. Repeat step 7 and 8 on the other side of the Batt.

Other installation information: FirePro Ablative Coated Batts are not intended for use as load-bearing seals. Where a load-bearing seal is required, ROCKWOOL FireStop Compound should be considered.



For a comprehensive range of ROCKWOOL solutions for penetrating services passing through the Ablative Coated Batt, please refer to the applicable ROCKWOOL standard details available at www.rockwool.com/uk or contact ROCKWOOL Technical Solutions.

SPECIFICATION CLAUSES

50mm Ablative Coated Batt is associated with the following NBS clauses:

P12 Fire stopping systems

325 Boards – Mineral Bound Lightweight

360 Mineral Wool Rigid Batts

365 Mineral Wool Rigid Batts – Ablative Coated





FirePro 60mm Ablative Coated Batt

Fire stopping solution for voids in walls and floors



The ROCKWOOL Ablative Coated Batt comprises a high-density stone wool core, pre-coated on both sides with our high-performance ablatively coating.

Ablative Coated Batt has been comprehensively tested as part of the ROCKWOOL FirePro range of fire protection products, specifically for use in service penetrations, head of wall and other void seals.

- Can provide fire resistance from a single thickness batt
- Suitable for sealing 20m long x 1.2m high voids at head of wall
- Suitable for large unframed voids up to 7.02m²
- Tested with dampers
- Tested as part of the FirePro suite of solutions
- Lightweight and simple to install
- Tested for air tightness, providing an additional smoke and acoustic seal

ROCKWOOL 60mm Ablative Coated Batt provides fire stopping solutions in walls and floors, reinstating the fire resistance.

60mm Ablative coated batt is also tested for acoustic and air leakage performance.

APPLICATIONS

- Multiple substrates including: solid walls and floors; flexible walls
- Multi-service penetrations
- Head of wall
- Blank seals
- Face-fixed applications

For a fully comprehensive list of applications, please refer to the appropriate ROCKWOOL standard details available at www.rockwool.com/uk or contact the ROCKWOOL Technical Solutions Team.

PERFORMANCE

Fire performance

Tests have proved the capability of a single 60mm Batt to provide up to 4 hours* fire resistance Integrity and Insulation ratings which are dependent upon the service penetrations and void size. Where 2 hours integrity and insulation are required we recommend the use of our 50mm Ablative Coated Batt. **Subject to the application*

60mm Ablative Coated Batt has been CE marked to EAD 350454-00-1104.

Use the links below to access further information on fire performance:

[ETA 22/0157 >](#)

[Certificate of constancy of performance - 2531-CPR-CXO10265 >](#)

[Fire Stopping Standard Details Guide >](#)

Acoustic performance

Tested for head of wall:

- Rw= up to 52db (2 x Coated batts)
- Rw= up to 38db (1 x Coated batts)

The correct use of Coated batt within concealed cavities and voids will reduce the level of transmitted sound:

- Rw= up to 52 db (2 x Coated batts) - incorporating 48mm O/D PVC /15mm copper pipe penetrations.
- Rw= up to 34 db (1x Coated batts) - incorporating 48mm O/D PVC /15mm copper pipe penetrations.

For specific acoustic requirements please contact ROCKWOOL Technical Solutions.

PRODUCT INFORMATION

Property	Description
Length	1200mm
Width	600mm
Thickness	60mm
Fire resistance	*Up to 4 hours
Density	180kg/m ³
Air leakage	0.41m ³ /h/m ²

**Subject to the application*

STANDARDS AND APPROVALS

Certificate
BS EN 1366-3: 2009 and the dedicated fire resistance standard for linear joint seals, BS EN 1366-4:2006. Ablative Coated Batt has been classified in accordance with BS EN 13501-2. 60mm Ablative Coated Batt is also comprehensively tested to BS 476 Part 20 & 22.
CE marked to EAD 350454-00-1104.



For further information on the full scope of fire performance please refer to the appropriate standard details available www.rockwool.com/uk or contact ROCKWOOL Technical Solutions.

Important: All Ablative Coated Batt fire resistance tests were conducted using ROCKWOOL FirePro ancillary products as appropriate.

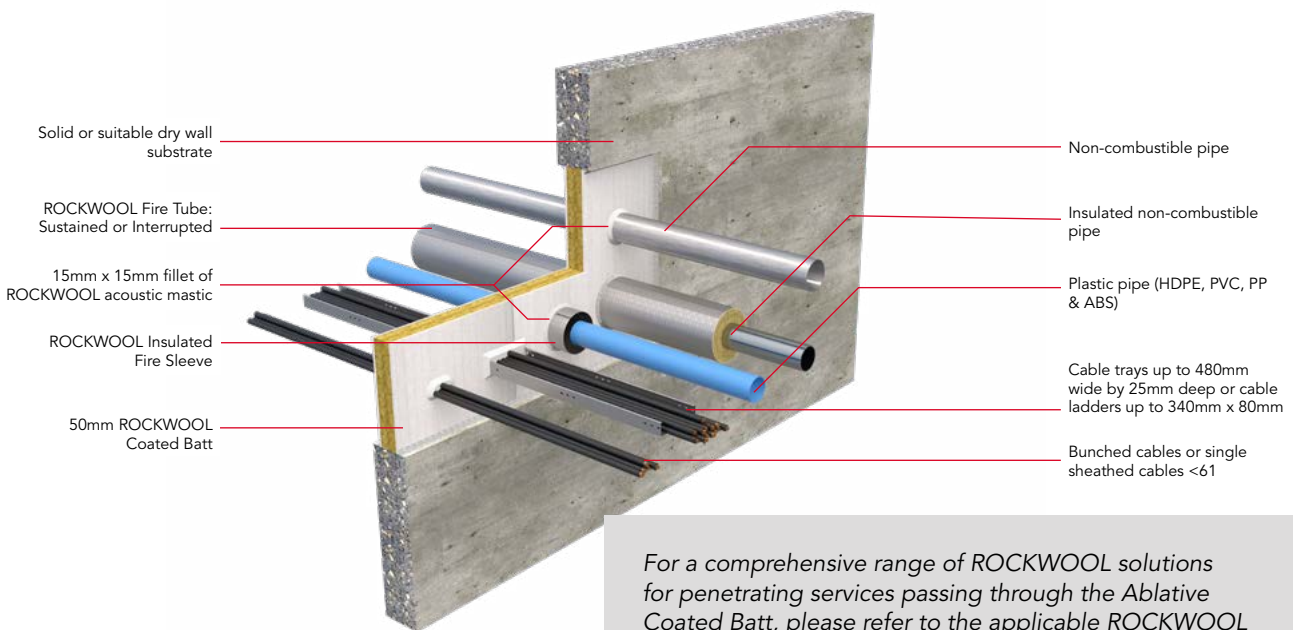


INSTALLATION

1. Make sure that the area within the aperture is clean of any debris and remove any dust from the edges.
2. Cut ROCKWOOL Ablative Coated Batt to the size and shape required to fit the aperture ensuring that batt will make a tight fit with all edges of the aperture.
3. Cut rectangular holes from the coated batt to accommodate cable trays or ladders containing cables.
4. Cut the Coated Batt across its width at the mid-point of each rectangular hole to enable the Batt to be fitted into the aperture.
5. Apply ROCKWOOL Acoustic Intumescent Sealant to all edges of the Batt ensuring that an even cover is achieved over the entire thickness of the Batt. This should include the outer edges of the Batt and the edges of the cuts made across the Batt to allow fitting into the aperture.
6. Insert the Batt into the aperture.
7. Apply a bead of ROCKWOOL Acoustic Intumescent Sealant approximately 15mm wide around the perimeter of the Batt ensuring that all gaps between the Batt and surrounding edges are fully filled.
8. Apply a bead of ROCKWOOL Acoustic Intumescent Sealant approximately 15mm wide where cables pass through the Batt. Ensure that the sealant fully enclosed each cable within the tray or ladder and that all gaps are fully filled.
9. Repeat step 7 and 8 on the other side of the Batt.

Note: For any areas of Batt where the coating has been damaged, repaint with the Ablative Coating. Ensure that there is no uncoated slab or bare mineral wool visible.

FirePro Ablative Coated Batts are not intended for use as load-bearing seals. Where a load bearing seal is required, ROCKWOOL FireStop Compound should be considered. For seals over 1200mm x 1200mm Batt to Batt joints are to be fully coated with FirePro Glue.



For a comprehensive range of ROCKWOOL solutions for penetrating services passing through the Ablative Coated Batt, please refer to the applicable ROCKWOOL standard details available at www.rockwool.com/uk or contact ROCKWOOL Technical Solutions.

SPECIFICATION CLAUSES

60mm Ablative Coated Batt is associated with the following NBS clauses:

P12 Fire stopping systems

325 Boards – Mineral Bound Lightweight

360 Mineral Wool Rigid Batts

365 Mineral Wool Rigid Batts – Ablative Coated





FirePro Ablative Liquid

Improves the fire resistant properties for ROCKWOOL stone wool slab



The FirePro Ablative Liquid is a water based, ready to use viscous paste which may be brush or spray-applied to stone wool slabs. The coating is available in white and in other colours subject to minimum order quantities. The coating may be over painted if desired* Ablative Liquid is supplied in 5L tubs.

- Suitable for spray or brush application
- Dries to give a sound, flexible white surface finish
- Provides a stable surface for adhesive and fixing sealants

Ablative Liquid is used to further improve the fire resistant properties of ROCKWOOL stone wool slabs.

The ablative nature of the coating resists flame spread and forms an insulated char which protects the stone wool slab.

APPLICATIONS

- Multiple substrates including: solid walls and floors; flexible walls
- Multi-service penetrations
- Head of wall
- Blank seals
- Face-fixed applications

For a fully comprehensive list of applications, please refer to the appropriate ROCKWOOL standard details available at www.rockwool.com/uk or contact the ROCKWOOL Technical Solutions Team.

*Please contact ROCKWOOL Technical Solutions for guidance on suitable paints

PERFORMANCE

Fire performance

FirePro Ablative Liquid is designed to re-seal the surface of FirePro Ablative Coated Batt where damage to the ablative coating may have occurred during installation.

FirePro Ablative Coated Batt has been tested to the dedicated fire resistance standard for penetration seals EN 1366-3. The independently prepared assessment, detailing the full scope of fire performance, is available from the ROCKWOOL Technical Solutions Team. Ablative Coated Batt fire resistance tests were conducted using FirePro Acoustic Intumescent Sealant and/or FirePro Glue.

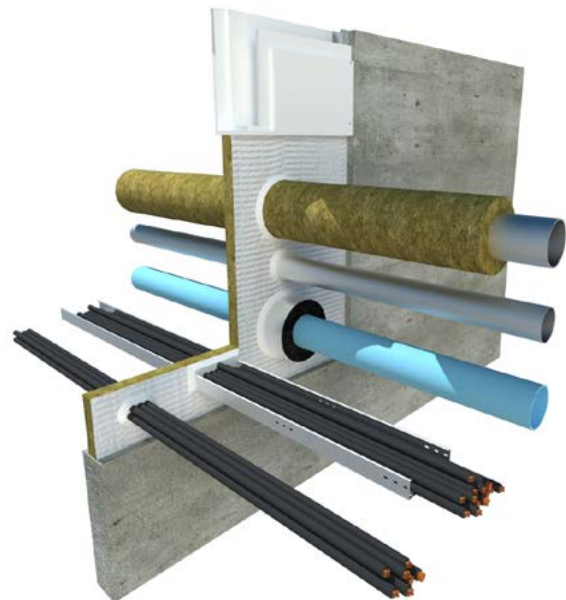
FirePro Ablative Liquid and stone wool slabs may only be used to fire protect service penetrations if supported by independent fire test evidence due to the variants in the density and thicknesses of stone wool slabs available.

PRODUCT INFORMATION

Property	Description
Cure system	Water loss
Colour	White
Specific gravity	1.3 – 1.4
pH	8.5 – 9.2
Flashpoint	None
Solids content (%w/w)	>58%
Application temp range	+10°C to +30°C
Vice temp range	-15°C to +75°C
Shelf life	Up to 12 months when stored in unopened containers under cool dry conditions. AVOID FROST and extremes of temperature
Durability	Up to 15 years when used as recommended

INSTALLATION

ROCKWOOL Ablative Coating can be spray or brush applied.



SPECIFICATION CLAUSES

FirePro Ablative Liquid is associated with the following NBS clauses:

P12 Fire stopping systems
325 Boards – Mineral Bound Lightweight
360 Mineral Wool Rigid Batts
365 Mineral Wool Rigid Batts – Ablative Coated



FirePro FireStop Compound

Firestop solution for cable, pipe and duct penetrations



FireStop Compound is a specially formulated gypsum-based compound, which is mixed with water to be trowelled or poured around service penetrations.

- Inhibits smoke
- Acoustic barrier
- Suitable for sealing around most types of service penetrations
- Load bearing capability
- Simple installation
- No smoke emission
- Unaffected by humidity

As part of the comprehensive FirePro range of fire protection products, ROCKWOOL FireStop Compound is used to provide a fire resisting seal around service penetrations in fire rated walls and floors.

APPLICATIONS

- Re-instating the fire resistance of wall and floor constructions
- Load bearing floors
- Wall penetrations
- Load bearing seals around unsupported fire dampers

PERFORMANCE

Acoustic performance

Thickness of compound (mm)	R _w (C;C _{tr}) - Specimen Only
50	40 (-1;-3) dB
100	44 (0;-3) dB
150	52 (-1;-6) dB

Test Reference: MTP/F16066/P003, P004, P007, P008, P009 and P010

For specific information on acoustic performance please contact ROCKWOOL Technical Solutions on 01656 868490 or technical.solutions@rockwool.com.

Load bearing capability

Thickness of compound (mm)	Max. load bearing area free of services
75	500 x 500mm
100	750 x 750mm

Openings with a clear area larger than 750 x 750mm need to be reinforced as outlined within the installation section. For further information on the reinforcement of openings greater than 750 x 750mm, please contact ROCKWOOL Technical Solutions on 01656 868490 or technical.solutions@rockwool.com.

Fire performance

For detailed information on fire performance, please contact the ROCKWOOL Technical Solutions Team: technical.solutions@rockwool.com.

PRODUCT INFORMATION

Property	Description
Pack size	22kg bag
Fire resistance	Up to 6 hours*
Load bearing capacity	Up to 2.5KN
Acoustic performance	Up to 52dB

STANDARDS AND APPROVALS

Certificate
FirePro FireStop Compound has been tested to BS 476 Part 20:1987
This product has been authorised for use in LUL surface and sub-surface premises when installed in accordance with this datasheet - please refer to the LUL Approved Product Register website www.LU-apr.co.uk for specific details.



INSTALLATION

Floor installations

In floors, a permanent shuttering made from 50mm ROCKWOOL slab (minimum density 140kg/m³) is cut and friction fitted between services and the edges of the floor slab. FireStop Compound is then trowelled over the shutter to a depth of 25mm thick. This is allowed to cure. Further FireStop Compound is then mixed to a pouring grade and tops the seal up to the required depth (See Figure 1).

FireStop Compound sets in 30-45 minutes and is capable of accommodating light foot traffic in approximately 72 hours.

Installation instructions – floors

1. Mix a bag of compound to 10 litres of water (3:1) by volume. Vary to suit site conditions.
2. Set the shuttering into the opening ensuring a tight fit so that once the required depth of compound is installed it finishes flush with the floor slab/screed unless otherwise specified.
3. Mix and pour compound until the required thickness is achieved.

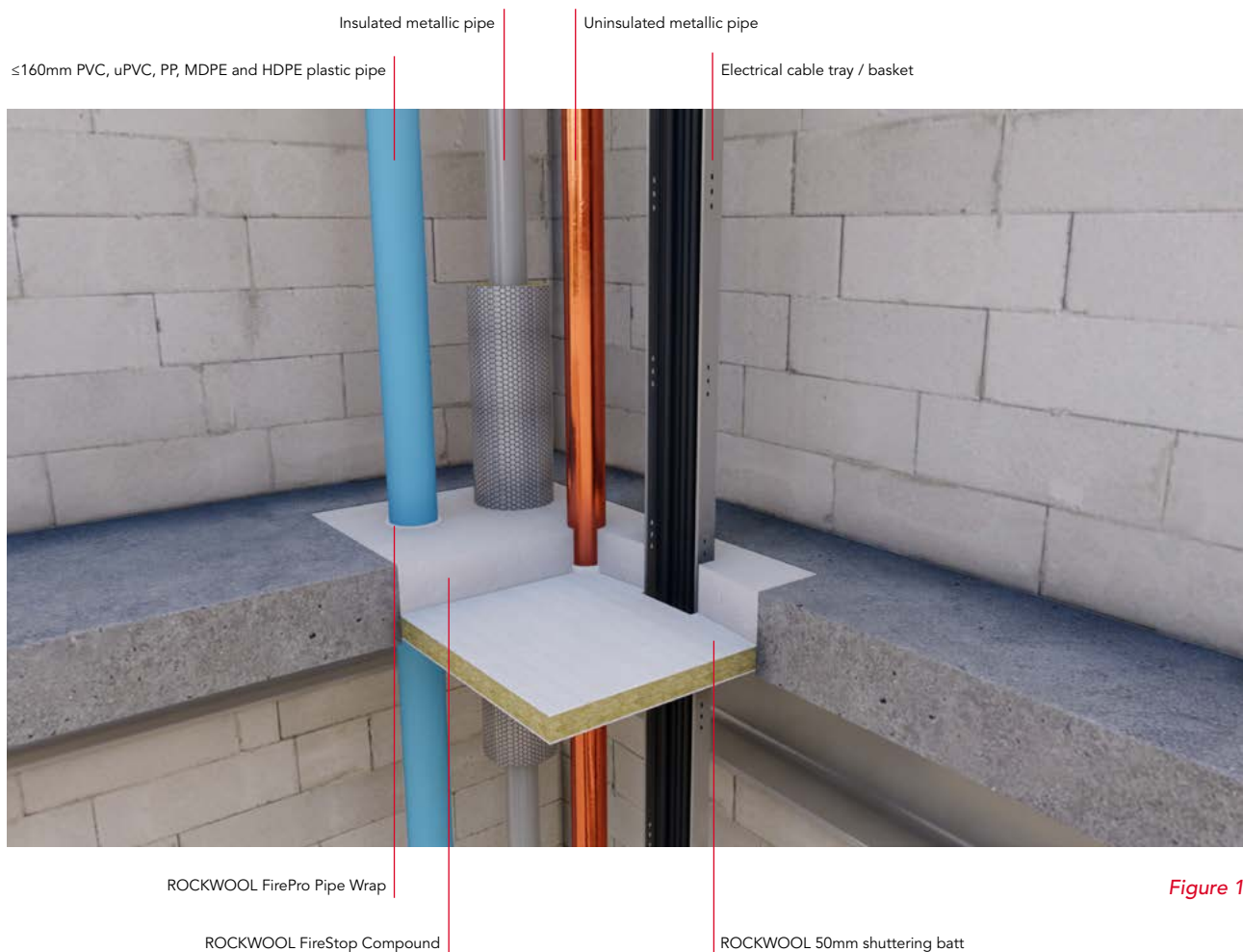


Figure 1

Wall installations

In wall applications (See Figure 2), FireStop Compound is mixed into a stiff consistency for trowelling into openings.

Installation instructions – walls

1. Mix a bag of compound to 10 litres of water (3:1) by volume. Vary to suit site conditions.
2. Apply the compound using the specified shuttering method (See Figure 3).
3. Trowel the compound starting at the base of the opening ensuring the correct thickness of material is installed. Work progressively towards the top of the opening until the barrier is complete. If the shuttering panel is set at the centre, repeat the process on the other side.



Figure 2

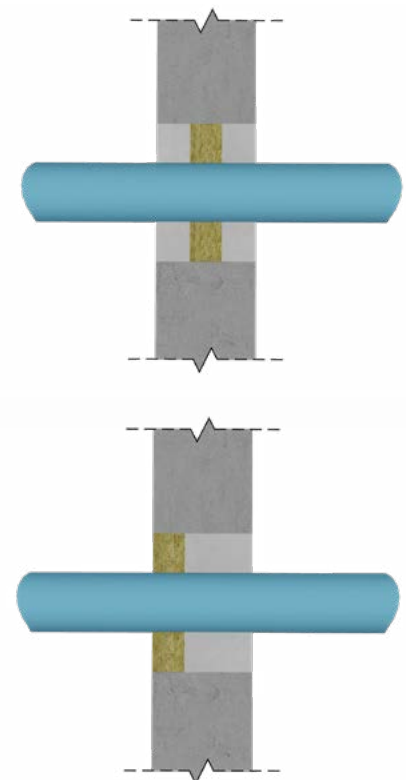


Figure 3

Coverage

Thickness of compound (mm)	Number of bags/m ²
75	3.15
100	4.20
150	6.30

The above calculations are approximate and based on 22kg bags.
The coverage rates shown do not take into account the area of service penetrations within the aperture.

SPECIFICATION CLAUSES

ROCKWOOL FireStop Compound is associated with the following NBS clauses:

P12 Fire stopping systems
340 Intumescent Mortar



FirePro High Strength FireStop Compound

High strength compound for reinstating the fire performance of floor and wall constructions



High Strength FireStop Compound is a specially formulated gypsum-based mortar, which is mixed with water to create a workable range from stiff to pourable mix. High Strength FireStop Compound is also suitable for pre-casting into convenient size blocks for use in wall openings.

- Unsupported spans of up to 1800mm
- High load bearing capacity
- Suitable for use with multiple service penetrations
- Can be formed into blocks
- Acoustic barrier
- Effective smoke seal
- Rapid setting

As part of the comprehensive FirePro range of fire protection products, ROCKWOOL High Strength FireStop Compound is used to provide a fire resisting seal around service penetrations in fire rated walls and floors.

Tested to EN 1366-3 High Strength FireStop Compound provides up to 4 hours* fire resistance.

**Subject to the application*

APPLICATIONS

- Re-instating the fire resistance of wall and floor constructions
- Load-bearing floors
- Wall penetrations
- Load-bearing seals around unsupported fire dampers

PERFORMANCE

Fire performance

High Strength FireStop Compound has been independently tested for use in walls and floors.

High Strength FireStop Compound has been certified by UL and CE marked to EAD 350454-00-1104.

Use the links below to access further information on fire performance:

[UL-EU Certificate - UL-EU-01149-CPR >](#)

[ETA 21/0777 >](#)

[Certificate of constancy of performance - 2531-CPR-CXO10261 >](#)

[Fire stopping standard details pack >](#)

Plastic pipework must be protected with either ROCKWOOL FireStop Pipe Collars or Intumescent Pipe Wraps. For further advice on specific applications and fire performance, please contact ROCKWOOL Technical Solutions on 01656 868590 or technical.solutions@rockwool.com

Acoustic performance

Thickness of compound (mm)	R _w (C;C _{tr}) - Specimen only
50	49 (0;-4) dB
100	52 (0;-3) dB

For specific information on acoustic performance please contact ROCKWOOL Technical Solutions on 01656 868490 or technical.solutions@rockwool.co.uk

Load bearing capability

High Strength FireStop Compound in floor spans of up to 1800mm without the need for further reinforcement. For further information on the load bearing capacity of High Strength FireStop Compound, please contact ROCKWOOL Technical Solutions.

PRODUCT INFORMATION

Property	Description
Description	Grey coloured free flowing powder
Pack Size	20kg bag
Density	1750-1900kg/m ³
Loadbearing	2.5KN/m ² UDL
Fire Resistance	Up to 4 hours*
Acoustic Performance	R _w 57dB (100mm Depth)
Max Unsupported Span	1800mm
Thermal Conductivity	0.45W/mK
Setting Expansion (%)	0.1
Typical Yield	±6bags/m ² at 100mm depth
Expected Shelf Life	6 months (When stored in accordance with the packaging instructions)

*Subject to the application



STANDARDS AND APPROVALS

Certificate
FirePro High Strength FireStop Compound has been tested for resistance in accordance with BS 476 Part 20 and EN 1366-3.
High Strength FireStop Compound has been classified as EI 120 in accordance with EN 13501-2
Third party certification through UL, Certificate No. UL-EU-01149-CPR
CE marked to EAD 350454-00-1104



This product has been authorised for use in LUL surface and sub-surface premises when installed in accordance with this datasheet - please refer to the LUL Approved Product Register website www.LU-apr.co.uk for specific details.

INSTALLATION

Mixing

High Strength FireStop Compound can be mixed preferably by mechanical paddle or manually, if required. Measure out the correct amount of clean water into a clean container to achieve the desired consistency. Avoid any cross-contamination with part-cured and new mixes as this can accelerate curing times.

High Strength FireStop Compound: water ratio
Pourable Mix ratio of 3 - 3Vz:1
Trowel Mix ratio of 4:1

Gradually add the High Strength FireStop Compound, stirring continually. Continue mixing until the compound is mixed to a smooth, even consistency. *Any spillage should be wiped up with a damp cloth before setting occurs. Mix only enough material sufficient for use within the recommended pot life (20-30 minutes). Pot life and set times will be reduced for lower water content and higher temperatures.

**High Strength FireStop Compound may stain pipes and services*

Installation should not be carried out when temperatures are above 35°C. Setting times are normally between 30 and 90 minutes.

Warning: Do not attempt to extend working time by remixing with additional water once the mortar has started to set, as this will interfere with the setting process. Always mix in clean buckets.

Fit a shuttering board to the bottom of the opening. Shuttering materials must be able to support the wet weight of the compound under pouring conditions. Pour High Strength FireStop Compound to the required 100mm thickness.

General installation requirements

Ensure that the aperture and services in question are tested with High Strength FireStop Compound, and the site conditions are within the application specification.

All services and apertures need to be clean and clear of all dust and loose particles. The aperture temperature needs to be at 5°C or above at time of installation. Plastic pipework must be protected with either ROCKWOOL FirePro Pipe Collars or Intumescent Pipe Wraps.

Upon installation make sure that you install the High Strength FireStop Compound to the recommended ratio for the aperture you are installing, make sure that you fill the full depth in a single pour to create a solid structure. Apply a minimum depth of 100mm in a single pour to achieve loadbearing capabilities.

Once filled, smooth off the High Strength FireStop Compound to produce a professional finish.

Wall openings (Figure 1)

For small holes and gaps, trowel a stiff mix into the opening to the correct depth. For larger holes, use an appropriate non-combustible shuttering material to support the mix until it sets, or, if a fair faced finish is required to both sides, consider using a sandwich construction. Alternatively, the High Strength FireStop Compound may be pre-cast into convenient sized blocks, a stiff mix being used as a bedding mortar. All combustible services (Plastic Pipes etc.) should have a ROCKWOOL tested fire rated closure device/material fitted prior to the pouring of the High Strength FireStop Compound.

Floor openings (Figure 2)

When sealing holes in floor slabs, appropriate shuttering must be installed, cut to fit tightly around any services within the opening, to support the wet mix until it sets. Non-combustible shuttering materials, such as mineral fibre slab, can be left in place, but combustible materials must be removed, after the mix has set. For complex penetrations it may be preferable to initially form a thin seal around all services with a nominal 5mm layer of the High Strength FireStop Compound mix. Once this has set, the remaining depth of seal should be poured in one operation. All combustible services (Plastic Pipes etc.) should have a tested fire rated closure device/material fitted prior to the pouring of the High Strength FireStop Compound.



Figure 1

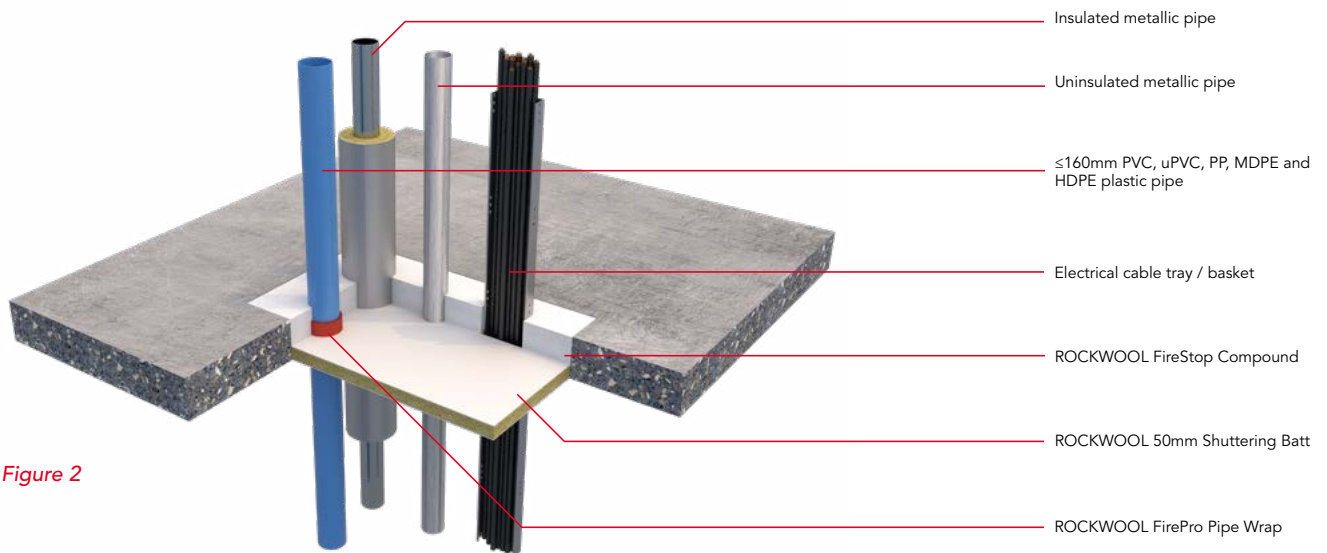


Figure 2

SPECIFICATION CLAUSES

ROCKWOOL FireStop Compound is associated with the following NBS clauses:

P12 Fire stopping systems

340 Boards – Intumescent Mortar



FirePro Intumescent Pillows CE

Temporary firestop solution for service voids in walls



FirePro Intumescent Pillows CE consist of intumescent material encased within a waterproof glass cloth bag. Intumescent Pillows CE are designed to create a temporary or permanent fire seal around all types of services to maintain continuity of fire performance of compartment walls. They are an ideal solution for applications where services are required to be changed or replaced on a regular basis.

Easy to install, they are simply packed tightly in between penetrating services and the wall.

- Easy to install
- Easy to remove and reinstate when changing services
- Dry system

ROCKWOOL Intumescent Pillows CE provide up to 2 hours* (EI 120) fire protection for differing services.

They are designed to provide fire stopping to metal

**Subject to the application*

APPLICATIONS

Under fire conditions, Intumescent Pillows CE expand several times their original volume to form an effective seal around service penetrations.

Intumescent Pillows CE are suitable for use with:

- Metal pipework
- Plastic conduits
- Cable trays/ladders

Note: For applications inside metal cable trunkings please contact ROCKWOOL.

PERFORMANCE

Fire performance

ROCKWOOL Intumescent Pillows CE provide up to 2 hours* fire rating where services pass through fire-rated walls.

** Subject to the application*

Intumescent Pillows CE have been CE marked to EAD 350454-00-1104.

Use the links below to access further information on fire performance:

[ETA - 20/1126 >](#)

[Certificate of constancy of performance - 2531-CPR-CXO10263 >](#)

[Fire stopping standard details pack >](#)

PRODUCT INFORMATION

Property	Description
Length	330mm
Width	50mm, 200mm
Thickness	20mm, 25mm, 45mm
Fire resistance	Up to 2 hours* integrity and insulation (EI 120)
Application	Internal
Shelf life	N/A if stored indoors in a cool, dry, ventilated area
Acoustic	Airborne Sound Insulation Rw (C,Ctr) = 33 (0,-2)
Air permeability	Tested to EN1026

**Subject to the application*

STANDARDS AND APPROVALS

Certificate
FirePro Intumescent Pillows CE have been tested in accordance with BS EN 1366 Part 3: March 2009 achieving fire resistance of up to 2 hours* (EI 120) in walls and dependent upon service type. <i>*Subject to the application</i>
CE marked to EAD 350454-00-1104.





INSTALLATION

Installation in walls

1. Push the first Intumescent Pillow CE into the hole to be filled, so that the longest dimension (330mm long) spans across the wall with 75mm projection from either face.
2. Pack the hole tightly with additional Intumescent Pillows CE, staggering the joints, until it is tightly packed.
3. For wall penetrations, the pillows are normally self supporting, but for large openings with few penetrations, you may require a steel retaining mesh for support on both sides of the penetration.
4. Smaller pillows are used as appropriate to fill smaller gaps.

Installation of service penetrations

1. The total amount of cross sections of services should not exceed 60% of the penetration area.
2. The minimum permitted separation between adjacent seals/apertures is 200mm.
3. Pipes must be installed singular, cables require no minimum separation.
4. Services in walls shall be supported via steel angles/hangars/channels a maximum 250mm (BS EN 1366-3:2009) or a maximum 500mm (BS 476:Part 20:1987) from the face of the separating element.
5. Pipes must be perpendicular to the seal surface.

Plastic conduits or trunking should be cut short by at least 100mm either side of pillow seal.

Coverage

Estimating quantities:

Pillow size (mm)	Approximate number
330 x 200 x 45	113 per m ² opening
330 x 200 x 25	180 per m ² opening
330 x 50 x 20	As required to fill small voids



SPECIFICATION CLAUSES

FirePro Intumescent Pillows CE are associated with the following NBS clauses:

P12 Fire stopping systems
345 Intumescent pillows





Firepro Intumescent Putty Pads

Restrict the spread of fire in plasterboard partitions



Intumescent Putty Pads are manufactured from a red non-setting, flexible silicone based intumescent polymer. They will not harden, crack or dry out with age.

The intumescent properties activate as temperatures reach 200°C, restricting the passage of fire and smoke.

- Available for single & double sockets
- Up to 2 hours* fire resistance
- Reduces noise transfer
- Pre-cut for simple installation
- Maintenance free
- Tested for air tightness, providing an additional smoke and acoustic seal

**Subject to the application*

ROCKWOOL Intumescent Putty Pads have been developed for use in plasterboard partitions that have been partially penetrated by electrical socket boxes.

They are designed to maintain acoustic integrity and fire resistance.

APPLICATIONS

Intumescent Putty Pads are designed for (but not limited to) effecting a fire and acoustic seal around plastic or metal electrical socket boxes. Using the putty pads removes the need to install time-consuming baffle boxes.

Under fire conditions the intumescent pad expands to fill the void left by the burnt out electrical socket box, preventing the spread of fire through the plasterboard wall. The intumescent putty can also be used for upgrading the acoustic performance of partitions where electrical sockets boxes have penetrated the wall, reducing room-to-room noise transfer.

PERFORMANCE

Fire performance

Tested to BS 476 Part 20:1987/EN1366-3, Acoustic Intumescent Putty Pads offer up to 2 hour* fire resistance.

**Subject to the application*

Intumescent Putty Pads have been subjected to a European Technical Assessment on the basis of EAD 350454-00-1104.

Use the links below to access further information on fire performance:

[ETA 21-0851 >](#)

[Certificate of constancy of performance 2531-CPR-CXO10350 >](#)

[Fire Stopping Standard Details Guide >](#)

Acoustic performance

Measurement of airborne sound insulation was made in accordance with BS EN ISO 140-3:1995. Single number quantities were calculated in accordance with BS EN ISO 717-1:1997.

Intumescent Putty Pads (Internal socket) offer an airborne sound insulation rating of up to RW (C;Ctr) = 67 (-2; -7) dB*. Tests were conducted by BRE Acoustics who hold UKAS accreditation for the measurement of sound insulation in the field and the laboratory. The measurements were conducted using the procedures accredited by UKAS.

**Applicable only for ROCKWOOL FirePro Putty Pads in socket boxes*

PRODUCT INFORMATION

Property	Description
Suitable socket size	Single & double gang
Suitable socket type	Internally & externally mounted
Activation temperature	200°C
Application temperature	0°C to 40°C
Acoustic performance	Up to 67 dB
Shelf life	Up to 24 months
Fire resistance	Up to 2 hours*

**Subject to the application*



INSTALLATION

1. Remove the socket plate.
2. To ensure a high-quality seal, ensure the socket box is clean, dry and free from any dirt and dust.
3. Remove the protective paper from one side of the pad and align the pad so that it fits centrally over the switchbox. (can be installed to either the inside or the outside of the socket, depending on the fitting method / type of socket).
4. Firmly press and mould the pre-formed putty pad into the back of the box and around the cables ensuring the pad perimeter is sufficiently bonded.
5. Remove the remaining protective paper and trim off any excess material to leave a neat finish.
6. Replace and secure the socket plate.



Figure 1

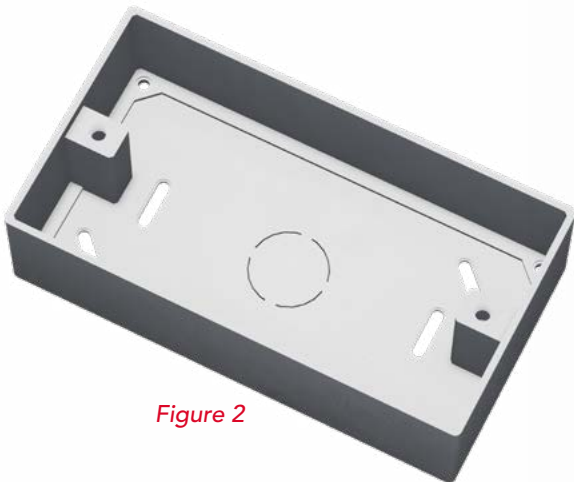


Figure 2

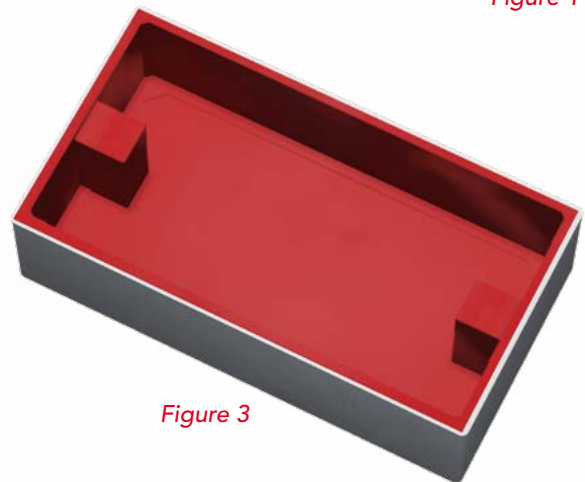


Figure 3

SPECIFICATION CLAUSES

FirePro Intumescent Putty Pads are associated with the following NBS Clause:

P12 Fire stopping systems

350 Intumescent Putty





FirePro Pipe Collar CE

Penetration sealing device for plastic pipework



Tested to the harmonised European Standard EN 1366-3:2009, FirePro Pipe Collar CE provides up to 4 hours* fire stopping in rigid floor constructions and up to 2 hours fire stopping in flexible/rigid wall constructions.

**Subject to the application*

FirePro Pipe Collar CE is slim in design (depth 30mm or 40mm) allowing it to be installed around a service where space is restricted. FirePro Pipe Collar CE can be installed on flexible wall, rigid wall and rigid floor constructions. When used around plastic combustible pipes, FirePro Pipe Collar CE will form a penetration seal to reinstate the fire resistance performance of the wall or floor construction.

FirePro Pipe Collar CE consists of a corrosion resistant powder coated steel sleeve, containing a flexible graphite based intumescent liner which is manufactured to suit standard diameter plastic pipework. Under fire conditions, the intumescent material within the collar expands, crushing the pipework and closing the void left by the pipework, preventing the passage of fire.

- Up to EI240* fire resistance
- Suitable for flexible wall and rigid wall/floor constructions
- Available to suit plastic pipe sizes ranging from 32mm to 160mm OD and PP pipes up to 250mm OD
- Tested in conjunction with FirePro Ablative Coated Batt seals

**EI - Integrity/Insulation, actual performance is subject to the application.*

Part of the comprehensive FirePro range, ROCKWOOL FirePro Pipe Collar CE is designed and tested to seal service penetration apertures containing plastic pipework. FirePro Pipe Collar CE provides a high-volume expansion and pressure seal during a fire.

Tested to the harmonised European Standard EN 1366-3:2009 and proven to perform as a penetration seal, FirePro Pipe Collar CE provides fire resistance for differing plastic pipework services and substrate constructions.

APPLICATIONS

Tested to reinstate the fire performance of rigid and flexible walls (minimum 100mm) and rigid floors (minimum 150mm) where combustible plastic pipes penetrate.

Fire resistance testing to EN 1366-3 and proven to perform for up to EI 240* in rigid floors and EI 120* in flexible/rigid walls. **Subject to the application*

Used to seal standard plastic pipe penetrations 32mm – 250mm diameter.

Standard plastic pipes tested are PVC-U, PP, PE.

FirePro Pipe Collar CE is supplied in assembled form, without fixings. The collar is wrapped around the pipe at the soffit of a rigid floor or both faces of rigid/flexible walls.

'UL-EU certification and any product label is only applicable to the specific scope and field of application as defined within the current and valid UL-EU certificate number UL-EU-01205-CPR. Any additional details, amendments or additions to the product, or any use outside the scope or field of application, outside of that stated within certificate number UL-EU-01205-CPR has not been reviewed or approved by UL.'

PERFORMANCE

Fire performance

FirePro Pipe Collar CE provides up to 4 hours* fire resistance for PVC-U, PP and PE pipes. *Subject to the application.

The performance of Pipe Collar CE will be limited to the performance of the substrate.

For further advice on sizes and suitable pipework types, please contact the Technical Solutions Team on 01656 868490

FirePro Pipe Collar CE has been certified by UL and CE marked to EAD 350454-00-1104.

Use the links below to access further information on fire performance:

[UL-EU Certificate UL-EU-01205-CPR >](#)

[ETA 20/1127 >](#)

[Certificate of constancy of performance 2531-CPR-CXO10264 >](#)

[Fire stopping standard details pack >](#)

PRODUCT INFORMATION

Property	Description	Test standard
Application temperature	-5°C to 40°C	
Application	Internal or External (Conditioned to Type X: -20°C - +70°C)	EOTA TR 024
Expansion rate	20:1	EOTA TR 024
Expansion pressure	1.30	EOTA TR 024
Plastic types	PP, PVC-U, PE	
Colour	Red	
Fire resistance – rigid floors	Up to 4 hours	EN 1366-3:2009
Fire resistance – flexible & rigid walls	Up to 2 hours	EN 1366-3:2009
Fixing detail	3 No 60mm x 6mm Expanding Anchors – Rigid Floors 3 No Size 70 Wood Screws - Rigid Walls 3 No 50mm screw with penny washer - Flexible Walls 3 No 35mm Tap in Fixings - Rigid Walls & Floors 3 No 80mm Steel Pigtail Screws - Ablative Coated Batt seals in walls.	
Expected shelf life	N/A	Store in dry conditions unopened

STANDARDS AND APPROVALS

Certificate
FirePro Pipe Collar CE has been tested to BS EN 1366-3:2009
Third party certification through UL, Certificate No. UL-EU-01205-CPR
CE marked to EAD 350454-00-1104

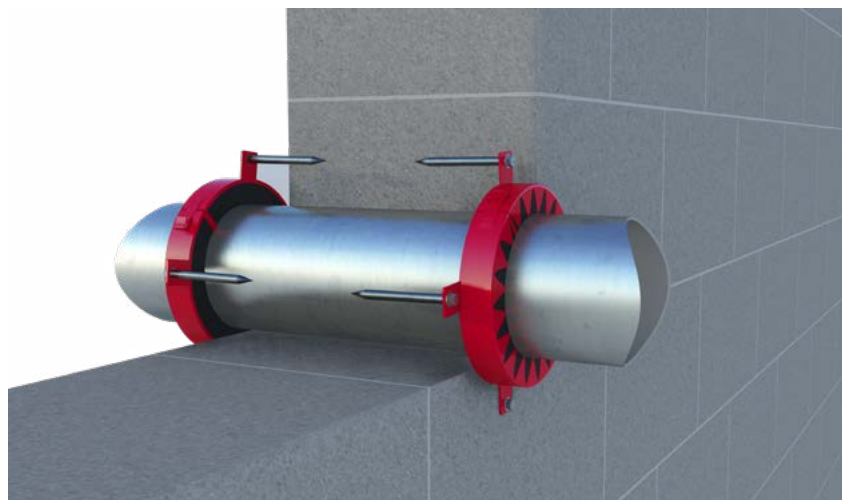




INSTALLATION

Installation of FirePro Pipe Collar CE in walls

1. Walls shall be a minimum thickness of 100mm or greater.
2. Flexible drywalls/partitions shall comprise a minimum of 2 layers of 'Type F' Gypsum board on both faces, with minimum 50mm studs.
3. Solid block, masonry and concrete walls shall have a minimum density of 780kg/m³ and a minimum thickness of 100mm. Aerated concrete block shall have a minimum density of 600kg/m³.
4. Fire Stopping seals at maximum 1200mm high x 730mm wide consisting of a double layer of Ablative Coated Batt seal 2 x 50mm or 2 x 60mm.
5. All walls shall have at least the same fire resistance as that required of the sealing system.
6. Services penetrating the division shall be suitably supported via steel angles, hangers or channels, no further than 400mm from the surface of the sealing system on both faces.
7. Multiple apertures must be separated by a minimum of 200mm in drywalls and concrete/masonry constructions.
8. Check services to be treated are within scope of test data.
9. All services and apertures need to be thoroughly clean and clear of dust and loose particles.
10. Temperature to be 5°C or above at time of installation.
11. Gaps of up to 10mm wide around the service within the substrate can be filled with a minimum 5mm deep FirePro Acoustic Intumescent Sealant.
12. In rigid walls, for gaps greater than 10mm wide, ROCKWOOL FireStop Compound can be used.
13. Fixing straps on the FirePro Pipe Collar CE are opened up and the collar is simply fitted around the plastic pipe with the fixing tabs closest to the face of the wall.
14. Lock the FirePro Pipe Collar CE around the pipe by closing the fixing strap. The collar is pushed flush to the surface of the wall.
15. The collar is then securely fastened to the substrate by means of fire rated fixings to suit the substrate and installed through the fixing tabs. Steel pig tail screws minimum 80mm are utilised to secure the collar through to the Ablative Coated Batt.
16. Repeat for the other side of the wall if required.



Pipe Collar CE wall application

Installation of FirePro Pipe Collar CE in floors

1. Floors shall be a minimum thickness of 150mm or greater.
2. Concrete, aerated concrete or masonry floors shall have a minimum density of 650kg/m³.
3. All floors shall have at least the same fire resistance as that required of the sealing system.
4. Services penetrating the division shall be suitably supported via steel angles, hangers or channels, no further than 400mm from the upper surface of the floor.
5. Check services to be treated are within scope of test data.
6. All services and apertures need to be thoroughly clean and clear of dust and loose particles.
7. Temperature to be 5°C or above at time of installation.
8. Gaps of up to 10mm wide around the service within the substrate can be filled with a minimum 5mm deep FirePro Acoustic Intumescent Sealant.
9. For gaps greater than 10mm wide, ROCKWOOL FireStop Compound can be used.
10. Fixing straps on the FirePro Pipe Collar CE are opened up and the collar is simply fitted around the plastic pipe with the fixing tabs closest to the soffit of the floor.
11. Lock the FirePro Pipe Collar CE around the pipe by closing the fixing strap. The collar is pushed flush to the soffit of the floor.
12. The collar is then securely fastened to the substrate by means of fire rated fixings to suit the substrate and installed through the fixing tabs.

SPECIFICATION CLAUSES

FirePro Pipe Collar CE is associated with the following NBS Clauses:

P12 Fire stopping systems

380 Pipe collar: Surface mounted intumescent



FirePro Intumescent Pipe Wraps CE

Fire stop solution for plastic pipe penetrations



Intumescent Pipe Wraps CE are designed to seal service penetrations in apertures containing combustible plastic pipes. Pipe Wraps CE comprise layers of a graphite based intumescent sheet encapsulated in a polythene sheath. All Pipe Wraps CE are supplied in correct lengths to suit the pipe diameter.

Intumescent Pipe Wraps CE are tested to plastic services penetrating flexible and rigid wall constructions, rigid floors and in Ablative Coated Batt seals.

Pipe Wraps CE are tested with end capping configurations that cover U/C pipes.

- Simple to install with no mechanical fixings required
- Available to suit pipe diameters up to 250mm O.D.
- Up to EI 120* fire resistance
- Tested in conjunction with Ablative Coated Batt seals
- Dry system
- Water resistant

*Subject to the application

ROCKWOOL Intumescent Pipe Wraps CE are tested to EN 1366-3:2009 and CE marked to provide assurance where specified.

They offer a simple and more economical alternative to FirePro Pipe Collars CE, for fire stopping plastic pipework penetrations through fire rated walls and floors.

APPLICATIONS

- Fire stopping plastic pipe penetrations in rigid/flexible walls and rigid floors
- Can be applied to PVC, UPVC, Polypropylene, PE & HDPE pipe materials

UL-EU certification and any product label is only applicable to the specific scope and field of application as defined within the current and valid UL-EU certificate number UL-EU-01207-CPR.

Any additional details, amendments or additions to the product, or any use outside the scope or field of application, outside of that stated within certificate number UL-EU-01207-CPR has not been reviewed or approved by UL.

PERFORMANCE

Fire performance

FirePro Intumescent Pipe Wraps CE can provide up to 2 hours* fire protection to plastic pipework where it passes through fire rated walls and floors.

** Subject to the application*

Intumescent Pipe Wrap CE has been certified by UL and CE marked to EAD 350454-00-1104.

Use the links below to access further information on fire performance:

[UL-EU Certificate - UL-EU-01207-CPR >](#)

[ETA 20/1125 >](#)

[Certificate of constancy of performance - 2531-CPR-CXO10262 >](#)

[Fire stopping standard details pack >](#)

PRODUCT INFORMATION

Property	Description
Pipe diameter	Up to 250mm O.D.
Width	40mm
Thickness	2mm at 32mm, up to 12mm at 250mm
Fire resistance	Up to 2 hours*
Density	1.2g/cm ³
Expansion rate	20:1
Application temperature	-5 to 40°C
Shelf life	N/A if stored indoors in a cool, dry, ventilated area

**Subject to the application*

STANDARDS AND APPROVALS

Certificate
FirePro Intumescent Pipe Wraps CE have been tested to BS EN 1366-3:2009.
Third party certification through UL, Certificate No. UL-EU-01207-CPR.
CE marked to EAD 350454-00-1104.





INSTALLATION

The product is intended to be wrapped around the outside diameter of the pipework and is secured by means of a self-adhesive strip.

Apertures or core holes in the separating element shall be maximum oversize with respect to the pipe diameter as follows:

- 32mm - 50mm OD = 4mm
- 160mm OD = 10mm
- 200mm OD = 12mm
- 250mm OD = 14mm

The Intumescent Pipe Wrap CE is then positioned each side within the compartment wall or floor so that the edge of the product is left exposed at the face of the wall or soffit. The remaining annular space/gap shall be infilled using FirePro Acoustic Intumescent Sealant or for larger void sizes, the Intumescent Pipe Wrap CE can be sealed into the structure with ROCKWOOL FireStop Compound (see Figures 1 & 2 below).

Under fire conditions, the intumescent material expands against the structure and fills the void left by the burnt out plastic.

Where pipes are insulated, please refer to the Insulated Fire Sleeve data sheet.

Intumescent Pipe Wraps CE are used to prevent fire penetration in plastic pipes that pass through fire rated walls and floors for a specified period of up to 2 hours. They are manufactured as a sealed unit to the correct length and width to suit the pipe diameter and fire rating.

Walls should be a minimum of 100mm thickness and floors a minimum 150mm thickness. All walls should have the same or improved period of fire resistance as that required of the sealing system.

Services should be supported no further than 400mm from the surface of the separating element for walls and 400mm above the surface of the floor.

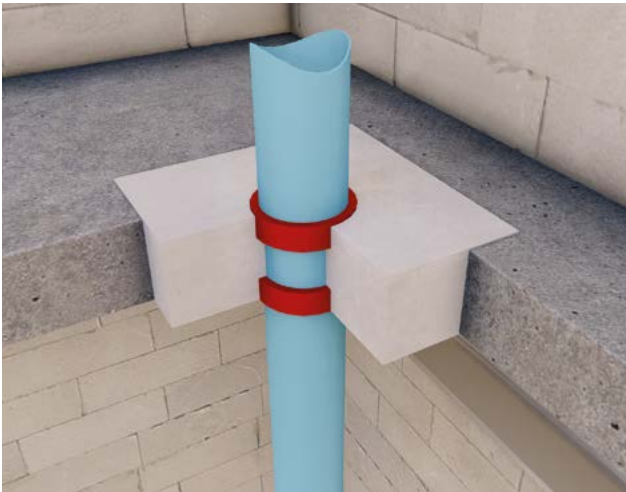


Figure 1

Intumescent Pipe Wrap CE sealed into compartment floor with ROCKWOOL FireStop Compound.

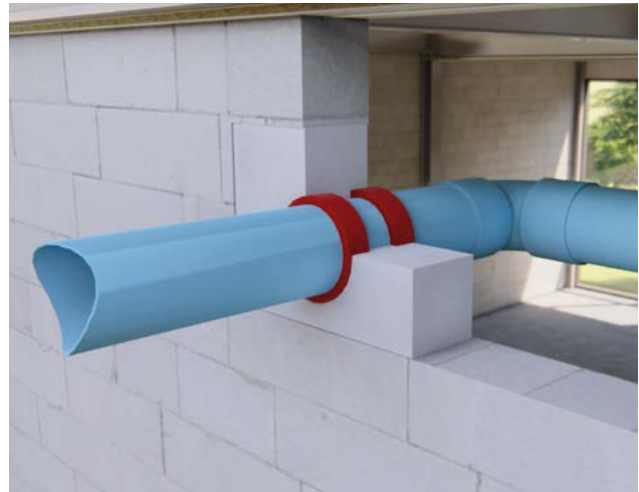


Figure 2

Intumescent Pipe Wrap CE sealed into a compartment wall with ROCKWOOL FireStop Compound.

Installation instructions

1. Check that the pipe surface is clean and clear of debris, dust or loose particles.
2. Aperture temperature should be 5°C or greater at time of installation.
3. Ensure that the appropriate Pipe Wrap CE is installed to suit the outside pipe diameter and required fire rating.
4. An annular space will be required around the service to allow sufficient installation depth.
5. Wrap around pipe and fix with integral self-adhesive strip. Ensure that when installing the Pipe Wrap CE to the pipework, that it is installed 5mm proud of the substrate's surface.
6. For larger voids, the Pipe Wrap CE can be sealed into the structure with ROCKWOOL FireStop Compound.
7. Slide into position ensuring that both edges are exposed either side of walls and floors.
8. Annular gaps or spaces present after installation of the Pipe Wrap CE can be infilled using FirePro Acoustic Intumescent Sealant.

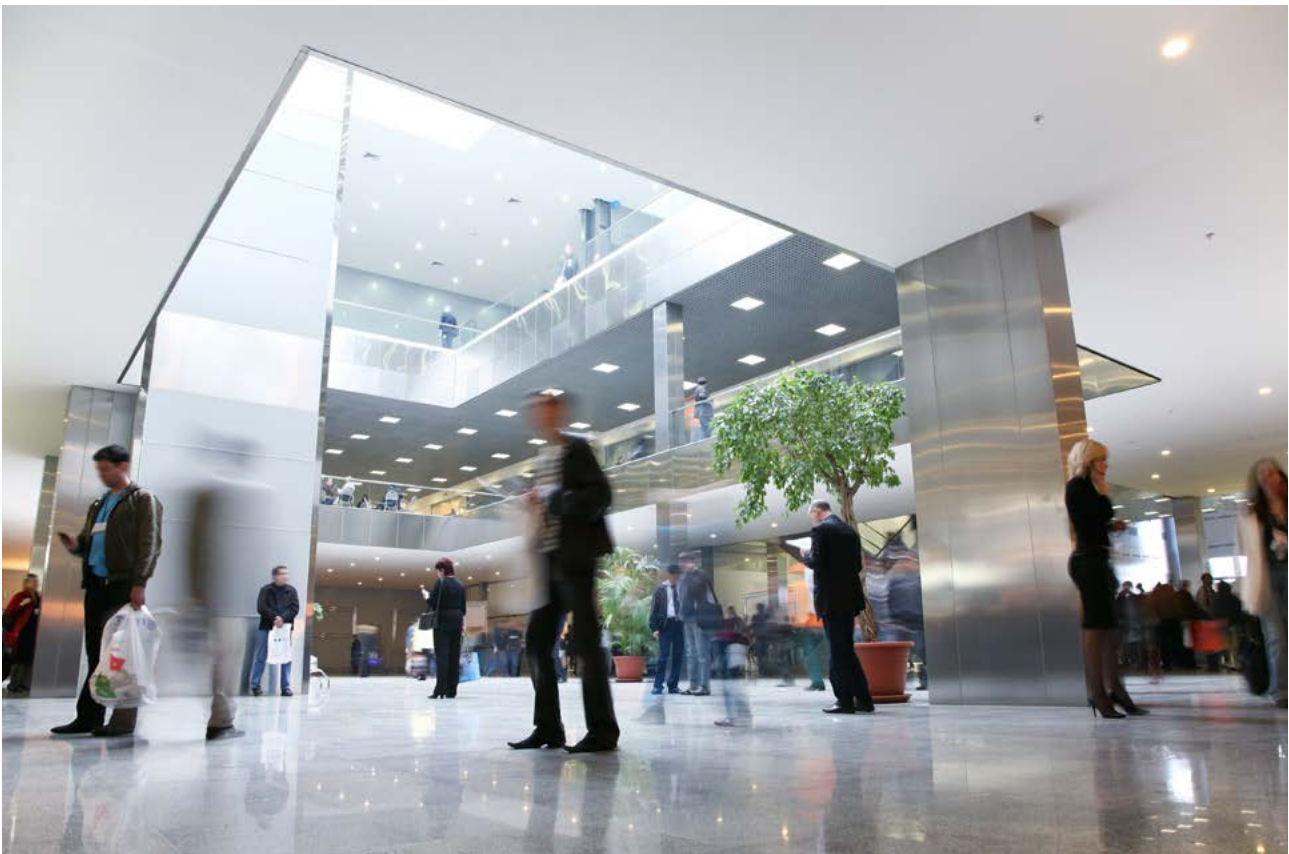
Note: Please refer to the relevant standard detail for maximum pipe size coverage and fire resistance rating achieved according to the seal type/application.

SPECIFICATION CLAUSES

ROCKWOOL Intumescent Pipe Wraps CE are associated with the following NBS clauses:

P12 Fire stopping systems

375 Pipe Collar - Insulated Wrap





FirePro Insulated Fire Sleeves

Fire stopping of insulated pipe penetrations



Insulated Fire Sleeves are a combination of ROCKWOOL stone wool and graphite intumescent. Supplied with a factory applied reinforced aluminium foil facing.

When thermally insulated plastic pipes pass through fire resisting walls and floors, the insulation is normally removed at the point of penetration to enable standard pipe collars and wraps to close the resulting void when the plastic softens and melts due to the effects of a fire. However, the removal of this insulation may result in the formation of condensation on cold pipework or heat loss from hot pipes. Insulated Fire Sleeves avoid this problem by providing both fire stopping and thermal insulation in a single product.

Insulated Fire Sleeves are intended for use on copper, steel and most types of plastic pipes, trunking and conduits to provide up to 4 hours* fire resistance.

- Quick, simple and accurate installation
- Maintains pipe insulation at penetration points
- Supplied with integral vapour barrier
- No mastic or ancillaries required
- Can provide thermal and acoustic insulation

*Subject to the application

Part of the comprehensive ROCKWOOL FirePro range of fire protection products, Insulated Fire Sleeves are a combination of stone wool and graphite intumescent.

Providing all the ROCKWOOL thermal, noise and fire benefits with an added intumescent effect, Insulated Fire Sleeves deliver both fire stopping and thermal insulation in a single product, helping to overcome the challenges traditionally associated with insulating and fire stopping plastic and metal pipework and rectangular vent ducts, conduits and trunking.

APPLICATIONS

Insulated Fire Sleeves should be installed to the same thickness as the pipe insulation (min 25mm thick). For uninsulated pipes, a thickness of 25mm is required to maintain the fire resistance of the wall or floor.

PERFORMANCE

Fire performance

FirePro Insulated Fire Sleeves have been tested with a range of pipe materials which penetrate walls and floors, achieving up to 4 hours* fire resistance. **Subject to the application.*

Insulated Fire Sleeves have been CE marked to EAD 350454-00-1104.

Use the links below to access further information on fire performance:

[ETA 21-0813 >](#)

[Certificate of constancy of performance 2812-CPR-0725 >](#)

[Fire stopping standard details guide >](#)

Acoustic performance

When tested onto copper pipes within a lightweight wall construction, Insulated Fire Sleeves achieved $R_w (C;C_{tr}) = 49 (-2;-8)$ dB

PRODUCT INFORMATION

Property	Description
Pipe diameter range	17mm - 169mm
Length	300mm
Wall thickness	25mm
Pipework operating temperature	0°C - 180°C
Fire resistance	Up to 4 hours*

**Subject to the application*

STANDARDS AND APPROVALS

Certificate
Insulated Fire Sleeves have been independently tested and assessed to BS 476; Part 20 and BS EN 1366-3: 2009 for periods of up to 4 hours* in concrete walls and floors, plasterboard partitions and ROCKWOOL Ablative Coated Batts.
CE marked to EAD 350454-00-1104



**Subject to the application*



INSTALLATION

Insulated Fire Sleeves are supplied 300mm long and are simply cut to the desired length and as a minimum, be cut flush with both faces of the wall/floor. When used in conjunction with PVC services or ROCKWOOL Ablative Coated Batts, they are required to extend beyond the face of the wall/floor. For details of how far they need to extend please refer to specification clause 2.

Maintenance

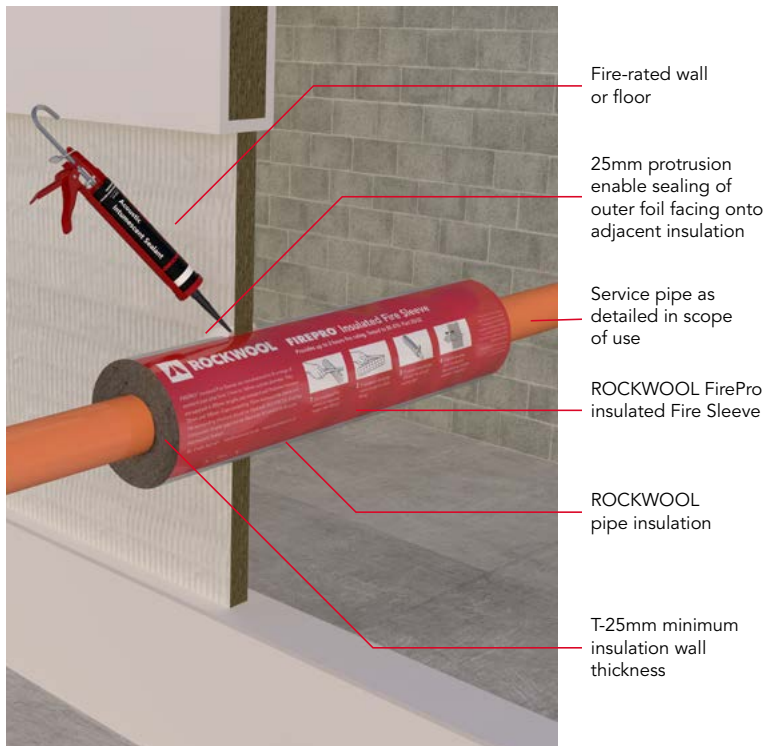
To maintain thermal efficiency, the Insulated Fire Sleeves should tightly abut any existing pipe insulation and where this is foil faced, all joints must be sealed with self-adhesive class O foil tape.

Other install info e.g. ancillaries

No specialist tools or ancillary materials are required for the fitting of Insulated Fire Sleeves. Insulated Fire Sleeves can accommodate irregularities in the division opening and the pipe O.D. of up to 15mm.

Multiple pipe penetrations can be accommodated in conjunction with Ablative Coated Batts.

A minimum thickness of 25mm is required for uninsulated pipes. Thicknesses of 25 to 100mm available to match insulation already installed on pipework. Manufactured to fit pipe diameters of 15 to 169mm.



1. Supporting construction designation:-
Floors: Cast concrete between 1100 and 2400kg/m³ density.
M=Masonry between 600 and 1500kg/m³ density.
PB= Plasterboard clad steel or timber stud partitions with fire resistance at least the same as the Fire Sleeve performance.
CB= ROCKWOOL 50 or 60mm thick Ablative Coated Batt.
2. Insulated Fire Sleeves should project by at least 25mm beyond the visible face of each Coated Batt. There must be at least 50mm width of Coated Batt between any fire sleeve and the edge of the aperture and also between individual Fire Sleeves.
3. If gaps exceed 15mm around the aperture and the sleeve, the gap should be filled with ROCKWOOL Acoustic Intumescent or FirePro FireStop Compound. If gaps exceed 8mm between the service and the sleeve, these can be infilled, locally where the service penetrates the aperture, with the Acoustic Intumescent Sealant.
4. The installed length of any Insulated Fire Sleeve shall be at least 60mm.

SPECIFICATION CLAUSES

FirePro Insulated Fire Sleeves are associated with the following NBS clauses:

P12 Fire stopping systems

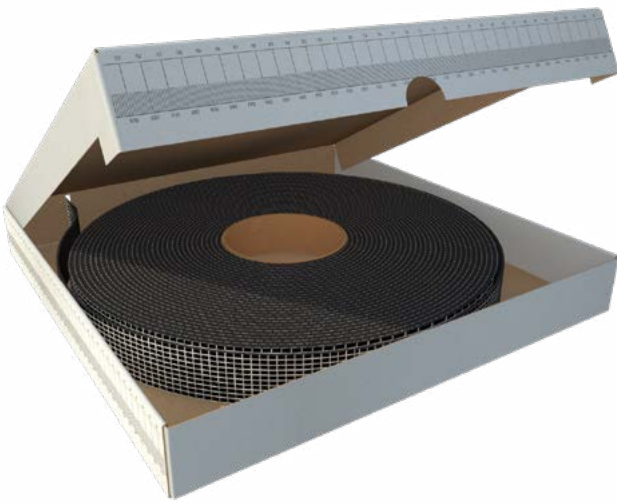
375 Pipe collar: Insulated Wrap





FirePro Intumescent Pipewrap Roll

Fire protection for pipework through fire rated walls and floors



Intumescent Pipe Wrap Roll comprises an intumescent material made from elastomeric thermoplastic polymers combined with active components that provide a high volume expansion and pressure seal in the event of a fire.

Intumescent Pipe Wrap Roll is supplied on 25m roll. The product is 40mm wide and 2mm thick, with integral adhesive tape for securing around the pipe. Depending on the service to be protected and the fire resistance required, multiple layers of wrap may be required, the exact number and positioning of the product is detailed in the performance section of this data sheet.

- Simple to install
- No mechanical fixings required
- Water resistant
- Supplied as a 25m long roll in box dispenser
- Available to suit pipes up to 250mm O.D.

A simple and more economical alternative which eliminates the need to carry a wide range of individually sized fire stopping product solutions.

Wrap on a roll is suitable for fire stopping a variety of combustible pipes and metallic pipes insulated with combustible insulation in both walls and floors.

APPLICATIONS

Install Intumescent Pipewrap Roll to provide up to 2 hours* fire protection to tested plastic pipework and insulated pipes where they pass through fire rated walls and floors. Installation to be fully in accordance with manufacturer's instructions. *Subject to the application

Applicable floor constructions to be a minimum 150mm thick, constructed from autoclaved aerated concrete/ concrete/masonry with a minimum density of 650kg/m³.

Applicable wall constructions should be a minimum 100mm thick. Rigid walls to be concrete/masonry blocks a minimum 450kg/m³. Flexible wall constructions should comprise with layers of 12mm gypsum type F plasterboard each side.

Constructions should achieve at least the same fire resistance performance as that required of the penetration seal.

'UL-EU certification and any product label is only applicable to the specific scope and field of application as defined within the current and valid UL-EU certificate number UL-EU-01204-CPR. Any additional details, amendments or additions to the product, or any use outside the scope or field of application, outside of that stated within certificate number UL-EU-01204-CPR has not been reviewed or approved by UL.'

PERFORMANCE

Fire performance

FirePro Intumescent Pipe Wrap Roll has been tested with varying substrates where services penetrate floors and walls. Pipe Wrap can provide fire resistance periods of up to EI 240*. **Subject to the application*

Intumescent Pipe Wrap Roll has been certified by UL.

Use the links below to access further information on fire performance:

[UL-EU Certificate - UL-EU-01204-CPR >](#)

[Fire Stopping Standard Details Guide >](#)

PRODUCT INFORMATION

Property	Description
Thickness	2mm
Width	40mm
Length	25m
Density	Approximately 1.2 g/cm ³
Volume expansion at 450°C	Approximately 25 times
Shelf life	18 months if stored in a cool, well ventilated area
Expansion pressure (N/mm ²)	Up to max. 1.30

STANDARDS AND APPROVALS

Certificate
Tested to BS EN 1366-4 fire resistance standard for service installations. Penetration seals. FirePro
Third party certification through UL, Certificate No. UL-EU-01204-CPR. This certificate is available to download at www.rockwool.com/uk .





INSTALLATION

The product is intended to be wrapped around the outside diameter of combustible pipework or the outside diameter of insulation on pipework and is secured by means of the integral self-adhesive strip.

1. Service apertures shall be a minimum 200mm from each other and 200mm from the seal edge.
2. Services should be securely supported no further than 400mm from the upper surface of the seal for floors or each side of the seal for walls.
3. Check that pipe surface and substrate are clean and clear of any debris.
4. Install the correct number of wraps for the service type and ensure the correct number of layers of wrap as detailed in the performance section of this data sheet.
5. Install the wrap into the wall or floor fitted flush to both faces of the wall or floor.
6. Apply a minimum 5mm deep bead of ROCKWOOL FirePro Acoustic Intumescent Sealant over the wrap around the service. Up to a maximum 12mm annulus to be filled with minimum 5mm depth ROCKWOOL FirePro Acoustic Intumescent Sealant.
7. Maintain a record of the installation.

Under fire conditions, the intumescent material expands against the structure and fills the void left by the burnt out plastic and/or insulation.

Maintenance

During normal use, no maintenance is required.







FirePro High Expansion Intumescent Sealant

Prevents the spread of smoke and fire



ROCKWOOL FirePro High Expansion Intumescent Sealant is water based acrylic sealant containing graphite. In the event of a fire, the active components provide a high volume expansion and pressure seal, closing off the void left by combustible materials.

ROCKWOOL FirePro High Expansion Intumescent Sealant is supplied in 310ml cartridges.

- Simple solution for sealing combustible pipes and metal pipes with combustible insulation
- Suitable for both walls and floors
- Compatible with cPVC pipes
- Tested in multiple substrates

FirePro High Expansion Intumescent Sealant is an easy to apply water based acrylic emulsion sealant containing graphite.

It reacts to temperatures above 135°C which is used to reinstate the integrity and insulation rating of compartment walls and floors where penetrated by combustible and non-combustible materials.

APPLICATIONS

FirePro High expansion Intumescent Sealant is comprehensively tested for a wide range of applications which include:

- Combustible pipes
- Metal pipes insulated with combustible insulation
- Cables (single cables or cable bunches)
- Other permanent services

PERFORMANCE

Fire performance

FirePro High Expansion Intumescent Sealant has been tested to BS EN 1366-3: 2009 and BS EN 1366-4: 2006 +A1:2010 and classified to EN 13501-2, providing up to 4 hours* fire protection in joints up to 30mm. *Subject to the application

High Expansion Intumescent Sealant has been certified by UL and CE marked to EAD 350454-00-1104.

Use the links below to access further information on fire performance:

[UL-EU Certificate - UL-EU-01202-CPR >](#)

[ETA 20/1131 >](#)

[Certificate of constancy of performance - 2531-CPR-CXO10267 >](#)

[Fire stopping standard details pack >](#)

PRODUCT INFORMATION

Property	Description
Form	Ready to use thixotropic paste
Cartridge size	310ml
Curing system	Water based
Specific gravity	1.5
Extrusion rate	350g/min
SAG	ˆ3min
Open time	30mins
Tack free time	60mins
Curing time	3 to 5 days
Shore (A) hardness	50
Solids	>80%
Application temperature range	+4°C to +35°C
Service temperature range	-15°C to 70°C
Shelf life	Up to 12 months when stored in unopened cartridges under cool, dry conditions. Avoid Extreme Temperatures

STANDARDS AND APPROVALS

Certificate
Third party certification through UL, Certificate No. UL-EU-01202-CPR. This certificate is available to download at www.rockwool.com/uk
FirePro High Expansion Intumescent Sealant has been CE marked against EAD 350454-00-1104
FBC™ System Compatible indicates that this product has been tested, and is monitored on an ongoing basis, to assure its chemical compatibility with FlowGuard Gold®, BlazeMaster® and Corzan® piping systems and products made with TempRite® Technology. The FBC® System Compatible Logo, FBC, FlowGuard Gold®, BlazeMaster®, Corzan® and TempRite® are trademarks of Lubrizol Advanced Materials, Inc. or its affiliates.



This product has been authorised for use in LUL surface and sub-surface premises when installed in accordance with this datasheet - please refer to the LUL Approved Product Register website www.LU-apr.co.uk for specific details. LUL Ref. 2454.



INSTALLATION

All surfaces must be clean and sound, free from dirt, grease and other contamination.

Prepare joint by cleaning as previously detailed and insert backer if required. Cut nozzle to the desired angle and gun firmly into the joint to give a good solid fill to the required depth. Strike off the sealant flush with the joint sides within five minutes of application, before surface skinning occurs. A small amount of shrinkage will occur on curing. If a flush finish is required, fill the joint slightly proud of the surface to allow for shrinkage.



Important information

- The sealant is not intended for application on bituminous substrates or substrates that can exude certain oils and plasticizers or solvents.
- The sealant is not recommended for submerged joints or areas exposed to high abrasion.
- The sealant is not suitable for food contact or medical applications.

A High Expansion Intumescent Sealant is different to standard intumescent sealants. It is tested and installed within a defined annular space between the service and the substrate. Please refer to the ROCKWOOL Standard Details for a complete list of tested systems.

SPECIFICATION CLAUSES

FirePro High Expansion Intumescent Sealant is associated with the following NBS clauses:

E40: Designed joints in in-situ concrete
530 Sealant
F30: Accessories/sundry items for brick/block/stone walling
610 Movement joints with sealants
L10: Windows/rooflights/screens/louvres
790 Fire resisting frames
L20: Doors/shutters/hatches
820 Sealant joints
P12: Fire stopping systems
395 Sealant-One part fire resistance acrylic





FirePro SpeedSeal

A fast sealing solution for small scale apertures



There are many instances in buildings where single or small bunched cables and conduits will need to be positioned through compartment walls. It is important that even the smallest penetrating service is effectively fire stopped to reinstate the fire performance of the wall.

FirePro SpeedSeal is a red putty-based penetration sealing solution available in 60mm and 100mm diameter discs. It has been tested in service openings 25mm x 25mm and 50mm x 50mm to seal penetrating services such as small metallic pipes, plastic pipes, cables and cable bunches.

- Quick and Easy to install
- Up to E120/EI60* fire resistance
- 2 size options to suit the majority of small openings
- Ideal for refurbishment or new build

Part of the comprehensive FirePro range, ROCKWOOL FirePro SpeedSeal is a putty-based penetration sealing solution.

Quick and easy to install, FirePro SpeedSeal is used to reinstate the fire resistance of flexible and rigid walls where cables and small conduits penetrate.

APPLICATIONS

- Tested to reinstate the fire performance of rigid and flexible walls (minimum 100mm) where small cables and conduits penetrate.
- Fire resistance testing to EN 1366-3 and proven to perform for up to EI 60*.
- Used to seal penetrations through service openings 25mm x 25mm and 50mm x 50mm.
- Tested in conjunction with small/medium metallic pipes, plastic pipes, small/medium cables and cable bunches.
- Can be used as a blank seal.

*Subject to the application

PERFORMANCE

Fire performance

FirePro SpeedSeal is specifically designed to be used around small cables, cable bunches, plastic and metallic conduits in flexible and rigid walls a minimum 100mm thickness. SpeedSeal has been proven by test to provide up to 120 minutes* fire resistance (E120) around services. *Subject to the application

SpeedSeal has been certified by UL.

Use the links below to access further information on fire performance:

[UL-EU Certificate - UL-EU-01206-CPR](#)

[Fire Stopping Standard Details Guide](#)

PRODUCT INFORMATION

Property	Description	Test standard
Application Temperature	>5°C	-
Thickness	4mm	
Colour	Red	
Density	1.55-1.6 g/cm ³	ISO 28111-1:2011
Fire resistance	Up to 2 hours	EN 1366-3:2009
Expected shelf life	12 months	Store in dry conditions unopened

STANDARDS AND APPROVALS

Certificate
FirePro SpeedSeal has been tested to BS EN 1366-3:2009
Third party certification through UL, Certificate No. UL-EU-01206-CPR





INSTALLATION

The product is intended to be wrapped around the outside diameter of combustible pipework or the outside diameter of insulation on pipework and is secured by means of the integral self-adhesive strip.

1. Service apertures shall be a minimum 200mm from each other and 200mm from the seal edge.
2. Services should be securely supported no further than 400mm from the upper surface of the seal for floors or each side of the seal for walls.
3. Check that pipe surface and substrate are clean and clear of any debris.
4. Install the correct number of wraps for the service type and ensure the correct number of layers of wrap as detailed in the performance section of this data sheet.
5. Install the wrap into the wall or floor fitted flush to both faces of the wall or floor.
6. Apply a minimum 5mm deep bead of ROCKWOOL FirePro Acoustic Intumescent Sealant over the wrap around the service. Up to a maximum 12mm annulus to be filled with minimum 5mm depth ROCKWOOL FirePro Acoustic Intumescent Sealant.
7. Maintain a record of the installation.

Under fire conditions, the intumescent material expands against the structure and fills the void left by the burnt out plastic and/or insulation.

Maintenance

During normal use, no maintenance is required.

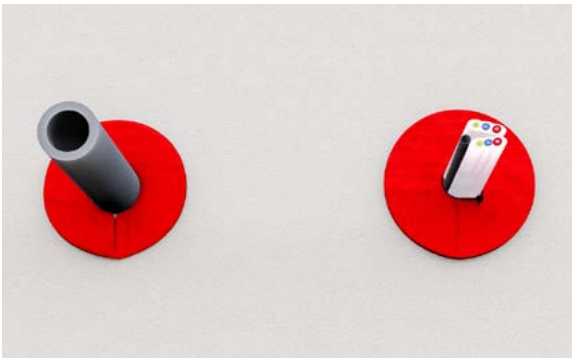


Figure 1
SpeedSeal for sealing around
conduits and electrical cables

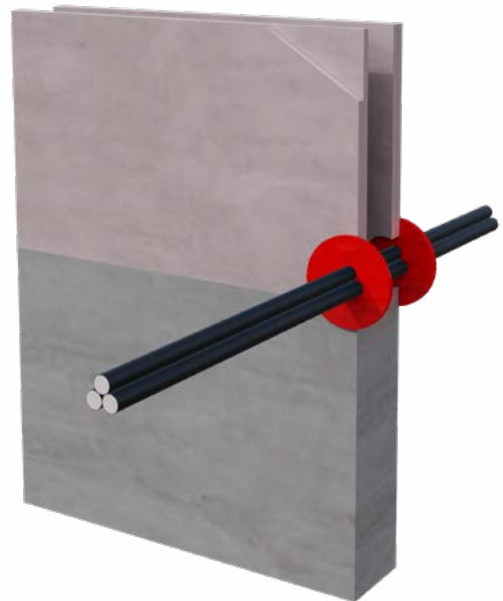


Figure 2
SpeedSeal for sealing around
small cable bunches

SPECIFICATION CLAUSES

FirePro SpeedSeal is associated with the following NBS clause:

P12 Fire stopping systems

350 Intumescent Putty





Section 2: Cavity Barriers & Cavity Firestops

Concealed spaces or cavities within the construction of a building can provide a clear path for fire and smoke to spread. Cavity Barriers and Cavity Firestops provide two important functions:

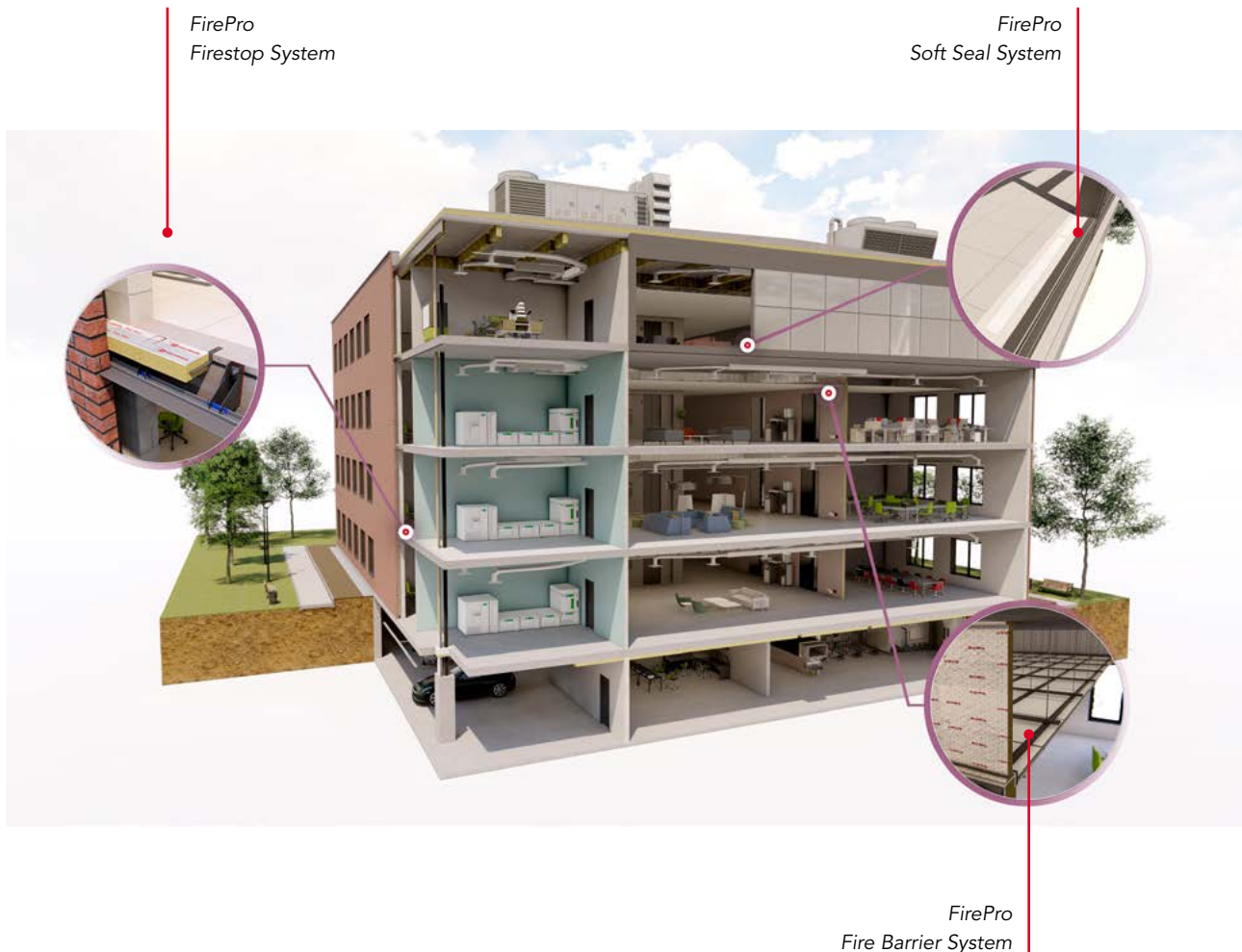
Cavity barriers

Used to close the edges of cavities, around openings (e.g. windows) or to sub-divide extensive cavities/voids in accordance with building regulations.

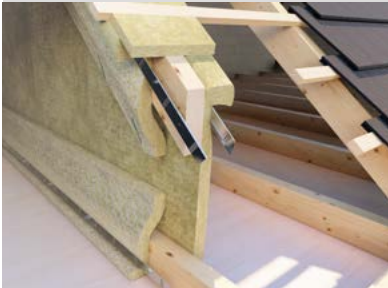
Cavity firestops

Used to continue the fire resistance of a compartment floor or wall within a cavity space or void e.g. junction between a compartment floor and external wall or above a compartment wall within a ceiling or roof void. It is important that the level of fire resistance achieved by the cavity firestop is equal to that of the compartment wall/floor.

Whether its single storey dwellings or multiple occupancy high rise buildings, ROCKWOOL provide a wide range of products and systems that have been tested for use as cavity barriers, cavity firestops or for use in both functions.



Core products



Fire Barrier System



Fire Barrier Slab



TCB & PWCB Cavity Barriers



FirePro SP FireStop EN

Useful documents and standards

ASFP Technical Guidance Document – TGD 17: Code of practice for the installation and inspection of fire stopping systems in buildings

ASFP Red Book: Fire stopping and penetration seals for the construction industry

ASFP: Ensuing best practice for passive fire protection in buildings

ASFP: On-site guide to installing fire stopping

BS 476-20: Fire test on building materials and structures. Method for determination of the fire resistance of elements of construction

BS EN 1366-4: Fire resistance test for service installations. Linear joint seals

BS EN 1366-4: Fire resistance test for service installations. Linear joint seals

BS EN 1363-1: Fire resistance tests. General Requirements

BS EN 13501-2: Fire classification of construction products and building elements.

Classification using test data from resistance to fire tests, excluding ventilation services.

ASFP (Association for Specialist Fire Protection) guidance documents can be sourced at www.asfp.org.uk



FirePro Fire Barrier System

Preventing the spread of fire and inhibiting the passage of smoke in concealed spaces



ROCKWOOL Fire Barrier is comprised of stone wool and has a galvanised wire mesh which is stitched to one side. Foil faced options and double sided wire mesh are also available. Fire Barrier systems have been developed to prevent the spread of flames and inhibit heat and smoke through concealed spaces in buildings and improve sound reduction.

Approved for LUL applications

- Patented 'quick-fit' system for up to 1 hour fire resistance
- Suitable for void heights up to 10.5 meters
- Provides airborne sound reduction
- Additional strength through wire mesh reinforcement
- Service penetration data available
- Fire resistance of up to 2 hours
- Flexible, accommodates movement

ROCKWOOL Fire Barrier systems offer labour-saving solutions to prevent the passage of fire and inhibit the spread of smoke within roof and ceiling voids.

This stone wool solution is suitable for void heights of up to 10.5 metres, supported by a stitched wire mesh.

APPLICATIONS

- Pitched roof voids
- Head of wall
- Concealed ceiling spaces
- Multiple substrates

PERFORMANCE

Fire performance

Rating required	Maximum drop without support frame	Maximum drop with additional support frame	Max width	Integrity	Insulation	Install specification	Supporting document
30 min cavity barrier	3m	10.5m	20m	30	15	Single 50mm layer FB, vertical joints butt jointed.	116911
		-		60	15		
30 min fire barrier	6m	N/A	20m	60	30	Single 60mm layer (plain or foil face) with a minimum 100mm overlapped and stitched joints on vertical joints*.	11970
60 min fire barrier	6m	10.5m	20m	60	60	2 layers of 50mm back to back butt jointed with staggered vertical joints between the back to back layers.	116912
90 min fire barrier	3.5m		20m	90	90		51812
120 min fire barrier	3.5m	9m	20m	120	120	2 layers of 60mm (plain or foil face) butt jointed, incorporating a 40mm aircavity between the layers.	44509

N.B. All extensions in drop height must incorporate a minimum 100mm overlap between the sections and stitched with 1.5mm galvanised wire.

*All stitching must be carried out using 0.9mm annealed and galvanised wire. Continuous wire stitching (100mm minimum) or separate lengths of wire secured by twisting ends together. Wire must penetrate through thickness of barrier.

Acoustic performance

The correct use of Fire Barrier within structural cavities and voids will reduce the level of transmitted sound.

Room to room attenuation	R _w dB
Typical lay-in grid suspended ceiling	30
Ceiling and 50mm ROCKWOOL Fire Barrier	42
Ceiling and 50mm ROCKWOOL Fire Barrier Foil Faced	44
Ceiling and 2x layers of 50mm ROCKWOOL Fire Barrier Foil Faced	50

Where plasterboard ceilings are used, add 2-3dB to above performances.

Note: Values quoted are approximate.



PRODUCT INFORMATION

Thickness	Length	Width
50mm	3700mm	1000mm
60mm	3000mm	1000mm

One or two sided foil face options available.

Wired mesh is available to both sides if required.

STANDARDS AND APPROVALS

Certificate

Fire Barrier Systems have been independently tested and assessed to BS 476: Part 22 by UKAS accredited laboratories.

ROCKWOOL Fire Barrier system achieves a reaction to fire classification of A1 as defined in BS EN 13501:1

They are third party approved for performance and quality by the Loss Prevention Council Certification board (LPCB) and are listed in their Fire and Security 'Red Book' - certificate no. 022c.

The product has been authorised for use in LUL surface and sub-surface premises when installed in accordance with this data sheet - please refer to the LUL Approved Product Register website www.LU-apr.co.uk for specific details – LUL ref: 2230.



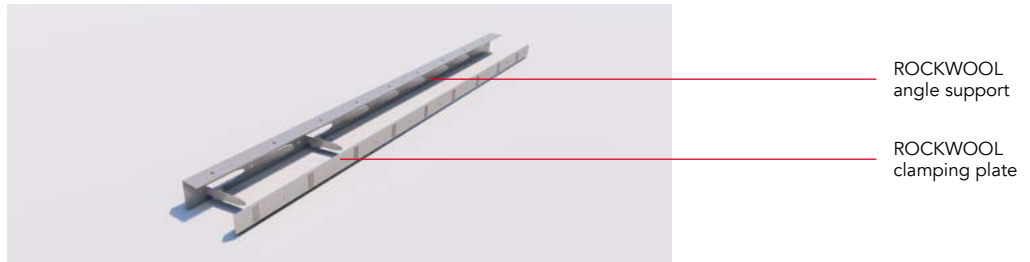
INSTALLATION

½ hour cavity barrier

Figures 4-9 show typical details for Fire barrier applied to a timber truss construction as a half hour cavity barrier within the roof section, to satisfy the requirements of building Regulation B3 - (4) i.e. 30 minutes fire integrity and 15 minutes fire insulation.

If the truss is constructed from a minimum timber size of 35 to 49mm thick, both sides of all truss members/bracing require protection from fire in order to minimise charring and retain strength. Figure 6 shows strips of 50mm Fire Barrier used on the reverse side of the truss (for this purpose). Nail plate fixings may fail prematurely in fire unless protected (see Figure 9).

The ROCKWOOL Fire Barrier Fixing System incorporates an angle support and clamping plate (Up to one hour)



For fixing to timber, the ROCKWOOL clamping plate is used, compressing the barrier to the timber, fixed at 450mm centres using No. 10 woodscrews.

To use the patented ROCKWOOL angle support system, bend tongues out to 90° and impale barrier onto them. The slotted clamping plate is then fitted by pushing the tongues through the slots, these are then bent over the face of the clamping plate completing the process.

Figure 4
Fire Barrier traverse to rafters

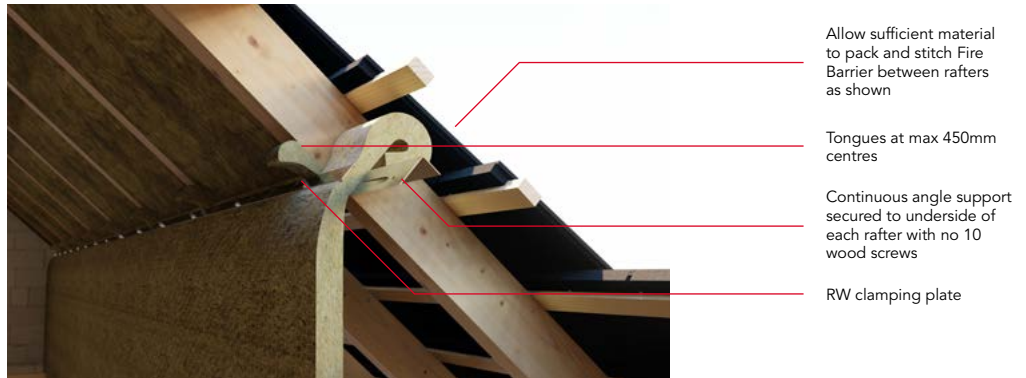
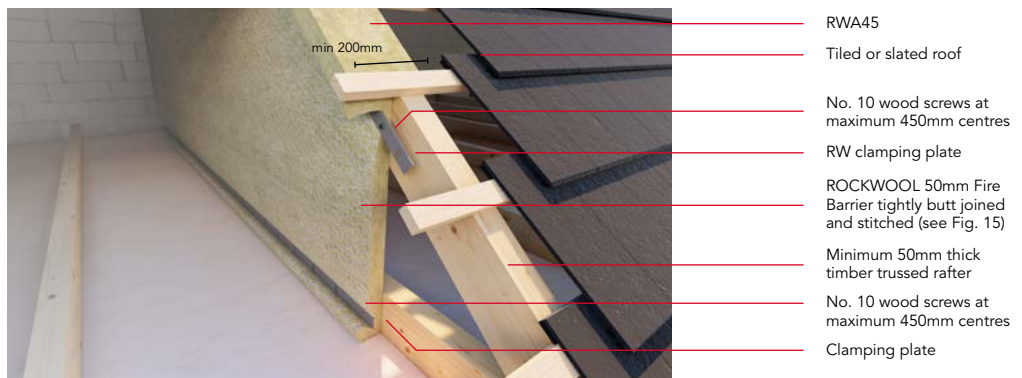


Figure 5
Half hour protection for timber truss construction 50mm thick or more.

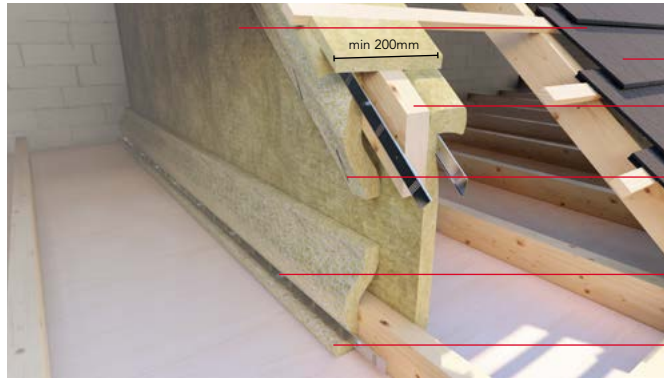
Note: nail plate protection required - see Figure 6





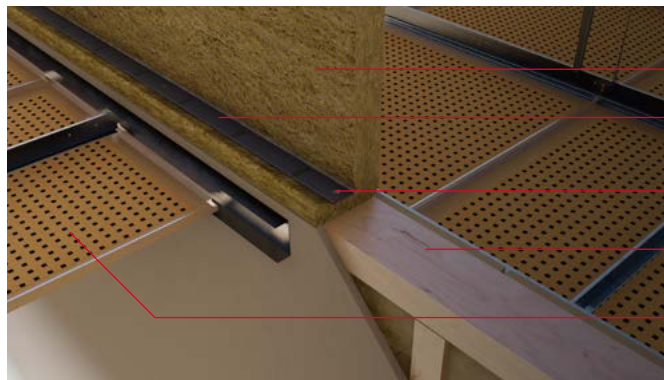
Fire stopping: Section 2 - Cavity barriers & cavity firestops

Figure 6
Half hour protection for timber truss construction 35 to 49mm thick.



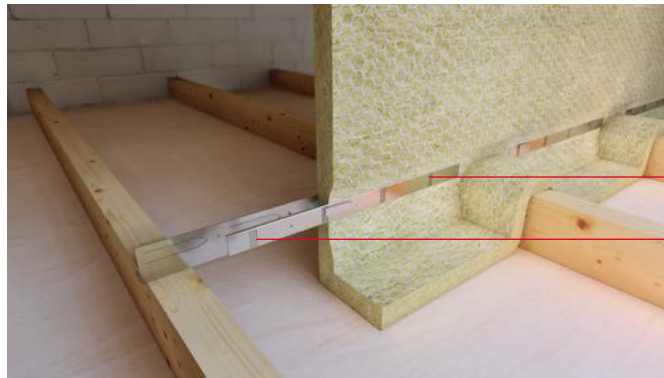
- RWA45
- Tiled or slated roof
- 35-49mm thick timber trussed rafter
- 0.9mm wire stitching to secure strips to main barrier stitches typically 100mm long
- No. 10 wood screws (or large washer and screws) at maximum 450mm centres
- 50mm Fire Barrier

Figure 7
Head of partition



- ROCKWOOL Fire Barrier
- RW clamping plate
- No. 10 wood screws at max 450mm centres
- Head plate
- Ceiling board

Figure 8
Barrier fitted transversely to timber joisted ceiling



- Tongues fixed at max 300mm centres
- Angle support fixed to ceiling joists

Figure 9
Nail plate protection

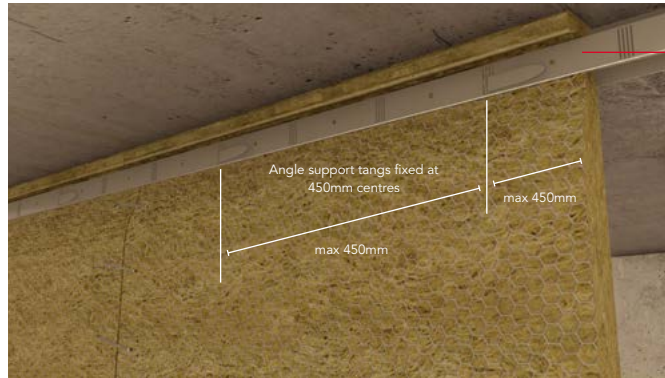


- 25mm thick ROCKWOOL BeamClad fixed with FirePro Glue and nailed, or 50mm Fire Barrier secured with screws and large square washers. Use 50mm nails for BeamClad and 70mm screws for Fire Barrier.

For fixing to concrete soffits (Figure 10-12), the pre-punched angle support is fixed using Hilti DBZ or Ejot ECL 35 hammer set anchors at max. 750mm centres. For fixing to steel purlins, use Hilti SMD 02Z (5.5 x 70mm) self-tapping screws at maximum 450mm centre.

Figure 10

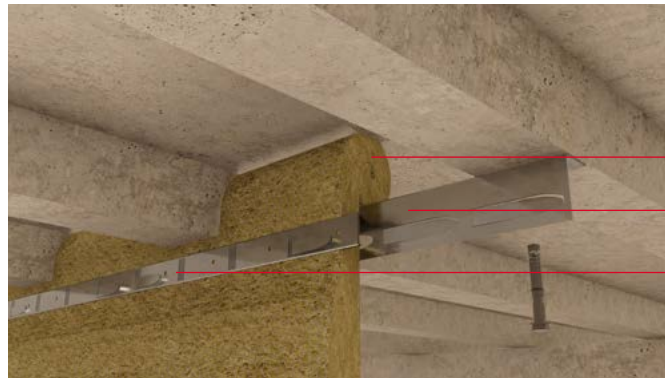
50mm Fire Barrier fixed to concrete soffit.



Support angle fixed to soffit at max 750mm centres

Figure 11

50mm Fire Barrier running across ribbed soffit - Section



RW clamping plate fixed at 450mm centres

Angle support fixed as Fig10

Barrier cut and packed into troughs and wired to prevent uncoiling

Figure 12

Alternative fixing to flat soffit or perimeter, appropriate to barriers with a shallow drop



50mm Fire Barrier compressed between soffit and clamping plate at max 450mm centres

Hilti DBZ 6/4.5 or Ejot ECL 35 hammer set anchor



60-30 Fire Barrier

If 30 minutes insulation is required, use 1 layer of 60mm plain or foil-faced fire barrier with 100mm vertical over lapped joints (Figure 13 & 14). The barrier is otherwise fixed for timber construction as previously shown on Figures 4-9.

Figure 13

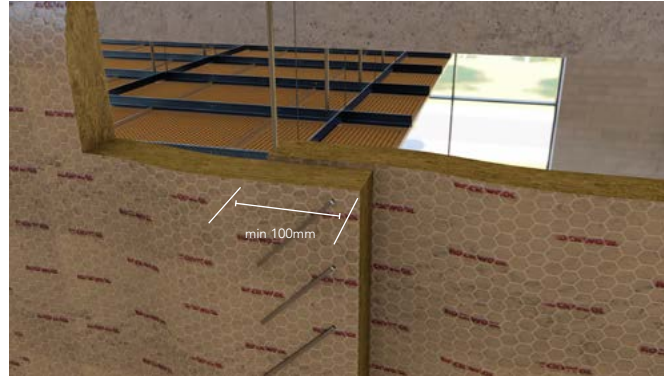
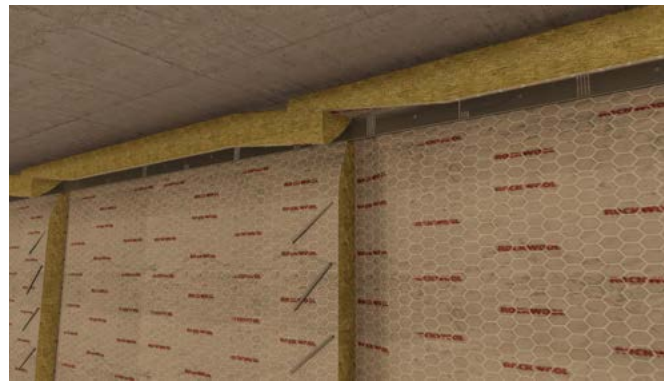


Figure 14



Common details

Extended drops

ROCKWOOL 50mm Fire barrier single and double layers, can be extended from a 3.5m drop to a maximum 6m drop by fixing an additional 2.5m section, stitched with overlapped joints as per Figure 16. For additional guidance and drops in excess of 6m, please refer to Figure 31 and associated guidance.

Wire stitching of butt joints in ROCKWOOL Fire Barriers

Adjacent barriers must be closely butt jointed, or overlapped, and through stitched with 0.9mm galvanised annealed wire (see Figure 15). It is essential that the barrier provides a good seal at its head, perimeter and at all joints. Where the barrier abuts a profile such as a trapezoidal deck, the material must be cut to suit and secured to fire stop the gap (see Figure 17). For extended drops, 1.5mm diameter galvanised and annealed wire is used (see Figure 16).

Figure 15

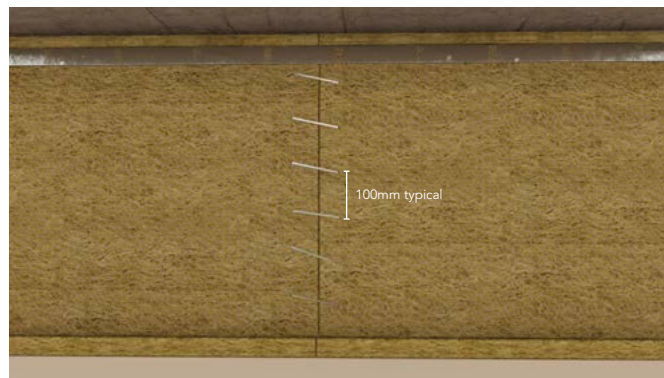
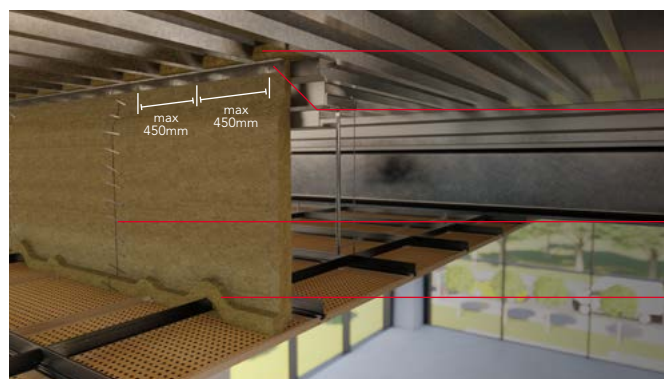


Figure 16



Figure 17



Fire Barrier cut and pushed up into profile as fire stopping

Angle or clamping plate fixing Fire Barrier to purlin with self tapping screws at 450mm centres (Hilti SMD 02Z 5.5 x 70mm)

Adjacent Barriers butt jointed and wired tightly together as Fig15

Fire Barrier draped over suspended ceiling and wired to grid, min 100mm lap. If not wired, overlap is min 150mm



Penetration details

It is regarded as good practice to adequately support or reinforce services penetrating compartment walls and cavity barriers, to prevent displacement. It is recommended that such supports should be no greater than 500mm from each face of the Fire Barrier.

To maintain the integrity of the Fire/Cavity Barrier when penetrated by services with a high melting point (such as steel or copper pipes, beams or trusses) the barrier is first cut locally to accommodate the service or structural member and then re-stitched as neatly as possible. The penetration is then lightly sleeved each side of the barrier to a minimum length of 300mm, using the same barrier material. Each sleeve should be securely stitched to the main barrier to produce a tight seal and prevent future detachment (see Figures 18 and 19). Where access is only available from one side, the double seal solution may be replaced by a single 'collar' detail - please contact our Technical Solutions Team for further advice.

If the penetrating service is manufactured from low melting point materials such as plastic or aluminium, then sleeving should be extended to at least 1000mm either side of the barrier.

This guidance applies to services such as pipes, sheathed cables and conduits, including those carried on steel trays.

For protected steel ductwork with a tested fire resistance performance (stability, integrity and insulation) at least the same as the Fire Barrier, 300mm sleeves should be applied either side of the main barrier, as for high melting point services above.

For information on achieving fire protection to steel ductwork, please refer to the ROCKWOOL Fire Duct System data sheet.

For non-fire protected ductwork, or that with a fire resistance performance less than the barrier, two sleeves should be applied to each side of the barrier, an inner sleeve of 1000mm and an outer sleeve of 300mm. All sleeves should be stitched to the main barrier.

The duct should also include an independently supported fire damper, located in the line of the main barrier. Reference should also be made to Approved Document B of England & Wales Building Regulations - Volume 1, Requirement B3, Section 7 and Volume 2, Requirements B3, Section 10.

Figure 18

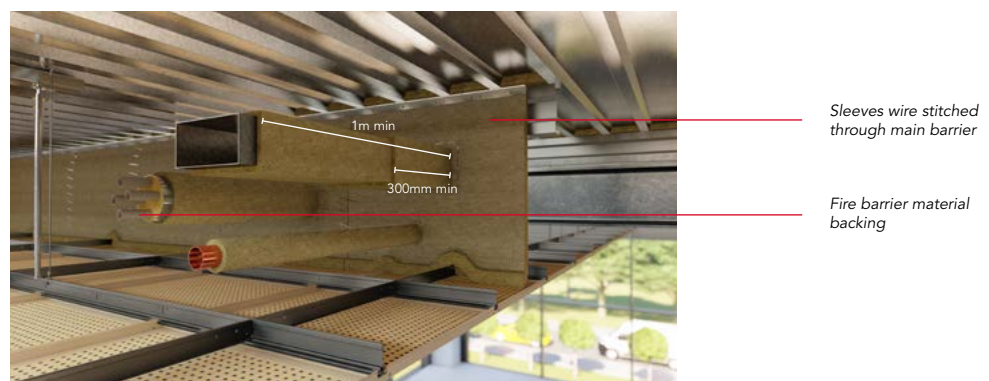


Figure 19



Sleeves to be stitched to main barrier

Off-cuts of Fire Barrier to be packed tightly into purlin void

1 hour Fire Barrier

The unique, patented ROCKWOOL support angle and clamping plate is used to fasten two 50mm Fire Barrier curtains with one support angle without the need for a cavity.

The ROCKWOOL support angle has tongues that are pushed out from opposite sides at 300mm max. centres. The ROCKWOOL Fire Barriers are then impaled on the tongues on both sides and clamped using the ROCKWOOL clamping plates. The tongues are finally bent over the clamping plates, completing the system.

The system uses 50mm Fire Barrier in a double layer with joints staggered. (Please note; wire reinforced sides should be placed outwards).

Figure 20



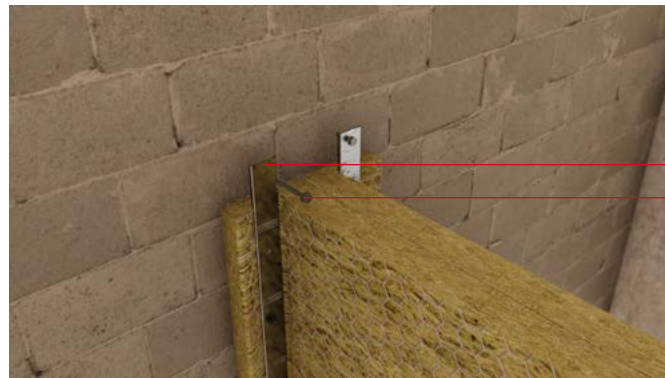
Concrete soffit

Fire Barrier support angle

Hilti DBZ 6/4,5 or Ejot ECL 35 hammer set anchor at max 750mm centres

Two layers of 50mm Fire Barrier with joints staggered

Figure 21

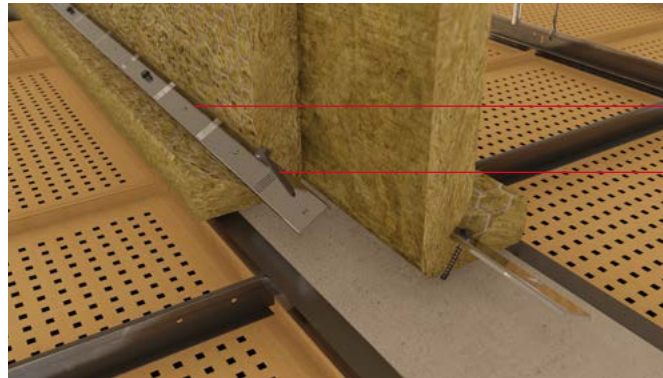


Clamping plate

Screw system at max 450mm centres

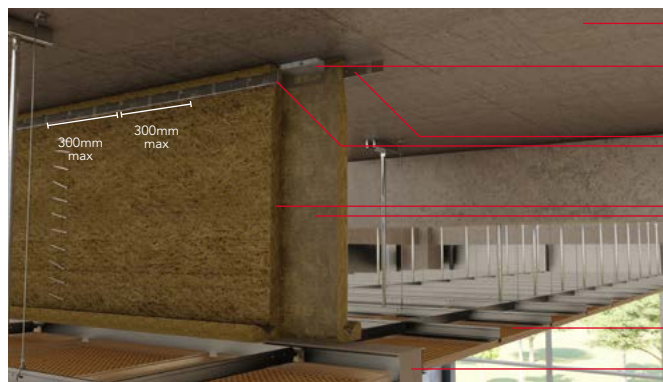


Figure 22



- Clamping plate
- Hilti hammer screws at max. 450mm centres

Figure 23



- Concrete soffit
- Support angle fixed to soffit at max 750mm centres
- Clamping plate fixed at 300mm centres
- Two layers of 50mm ROCKWOOL Fire Barrier, vertical joints staggered and stitched and clamped to head of wall
- Suspended ceiling
- Fire-resisting wall

Fixing to timber structure (1 hour)

When a 1 hour Fire Barrier is supported on structural timber (for example a trussed rafter), and the thickness of timber is 35-49mm, one layer of 60mm ROCKWOOL Fire Barrier must be placed on each side of the timber (see Figure 24). Where timber thickness is 50mm or greater, 2 layers of 50mm Fire Barrier are sufficient.

Figure 24



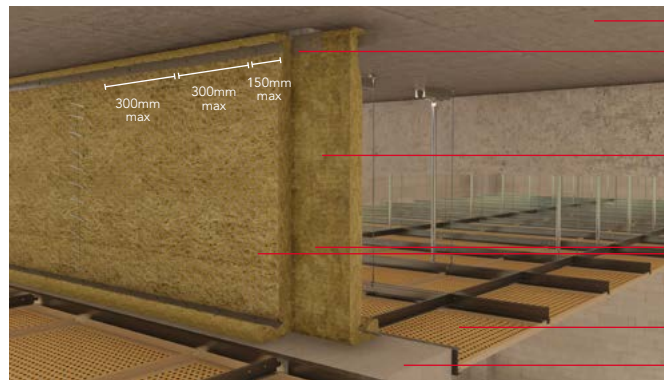
- Fill space between battens with 300mm wide RWA45
- RW clamping plate
- No.10 wood screws at maximum 450mm centres
- 35mm thick timber trussed rafter
- 60mm ROCKWOOL Fire Barrier tightly butt joined and stitched (see Fig.15)
- 1 hour fire rated ceiling
- Clamping plate
- No.10 wood screws at maximum 450mm centres

1.5 & 2 hour Fire Barriers

1.5 hour Fire Barrier

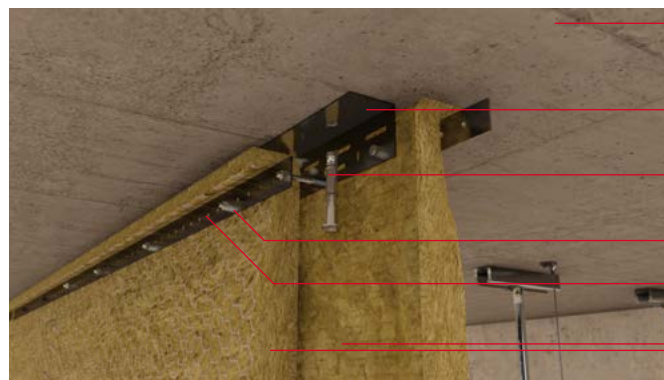
The ROCKWOOL 1.5 hour Fire Barrier system uses 2 layers of 50mm Fire Barrier with staggered joints fixed as Figures 25-27. Please note: Wire reinforced faces should be placed outwards.

Figure 25



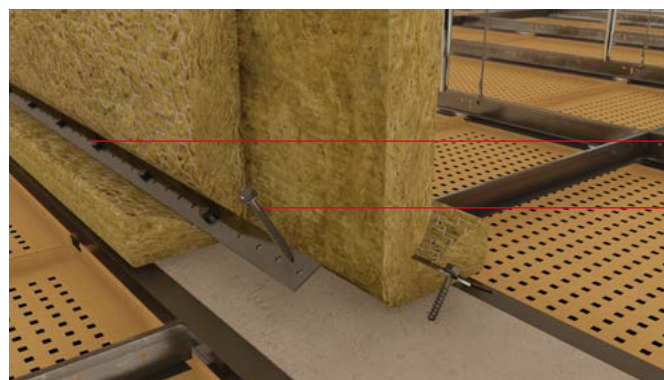
- Concrete soffit
- 2mm tested angle fixed to soffit at max 750mm centres (see Fig. 26).
- Clamped at max 300mm centres with M6 bolts and nuts
- Two layers of 50mm ROCKWOOL Fire Barrier, vertical joints staggered and stitched
- Suspended ceiling
- Fire-resisting wall

Figure 26



- Concrete soffit
- 2mm tested angle fixed to soffit at max 750mm centres
- M8 expanding bolt anchors at max. 750mm centres
- M6 bolts and nuts staggered each side
- 2mm tested punched strap
- Two layers of 50mm Fire Barrier with vertical joints staggered

Figure 27



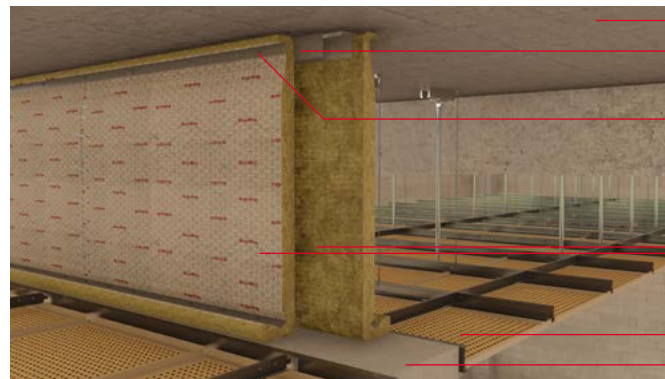
- 2mm tested punched strap
- Hilti HUS universal Screw System max. 300mm centres



2 hour Fire Barrier

The ROCKWOOL 2-hour Fire Barrier (see Figures 28-30) consists of two layers of 60mm (plain or foil-faced), wire stitched Fire Barrier with staggered vertical joints, separated by a nominal 40mm air space. The base or perimeter to which the barrier is fixed must be capable of remaining in place for 2 hours.

Figure 28



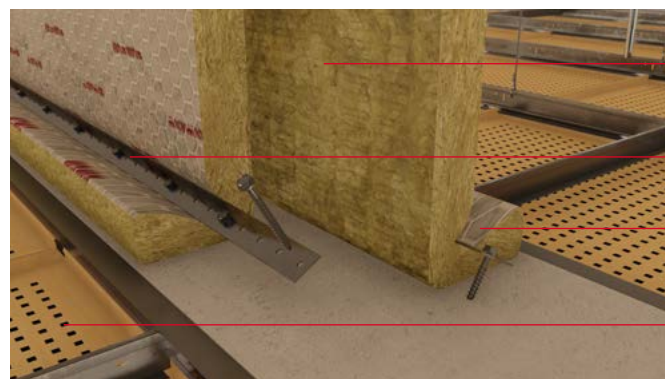
- Concrete soffit
- 2mm tested angle fixed to soffit at max 750mm centres (see Fig. 29).
- 2mm tested strap clamped at max 300mm centres with M6 bolts and nuts
- Two layers of foil-faced, wire reinforced 60mm Fire Barrier, with foil outwards, vertical joints, staggered and stitched. 40mm air space between the two layers
- Suspended ceiling
- Fire-resisting wall

Figure 29



- 2mm tested angle fixed to soffit at max 750mm centres
- M8 expanding bolt anchors at max. 750mm centres
- 2mm punched strap
- M6 bolts and nuts

Figure 30



- Two layers of foil-faced Fire Barrier
- 2mm punched strap and universal Screw System max. 300mm centres
- 2mm punched strap
- Ceiling

Angle and strap for 1.5% and 2 hour Fire Barriers

The following specification for slotted angles and straps is suitable for supporting ROCKWOOL Fire Barriers for 1.5 and 2 hours when tested to BS 476: Part 22. Slotted angles (62 x 41 x 2mm) and straps (38 x 2mm) manufactured from mild steel conforming to BS 1449: Part 1.1: 1991 and cold reduced to provide a minimum of 0.2% proof stress of 417 Mpa (27 tons/ in²) and conforming to BS 4345: 1968 (1986) - Specification for slotted angles (inc. flat strap).

OTHER INSTALLATION INFORMATION

General design considerations

A cavity fire barrier must be designed to restrict the passage of both hot smoke and flames for the minimum specified period, as listed in Approved Document B in support of the Building Regulations. In addition, it must be fixed in such a way that:

- It will remain effective in the event of structural movement
- There are no gaps where it abuts other elements of construction
- It complies with the requirements of Approved Document B of the Building Regulations

Extended drops

For periods of up to 60 minutes, ROCKWOOL Fire Barriers can be used for extended void heights between 3.5 and 6m without the need for a supported frame - see Figure 16 for joining barriers with overlap. For periods of up to 90 minutes, this drop height can be increased to 10.5m (9m for 120 minutes), by the use of a simple frame system constructed from slotted angles and straps (see Figure 31).

Further details are available from ROCKWOOL Technical Solutions Team.

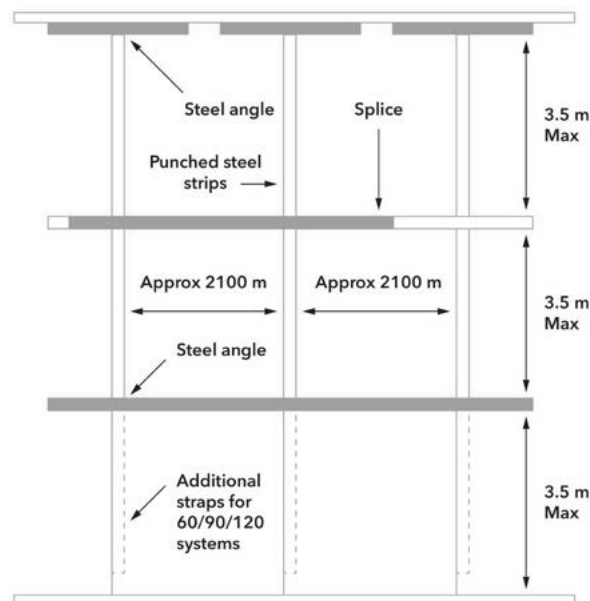
Fire barriers and dampers

Where ROCKWOOL Fire Barriers are installed in conjunction with fire dampers, the dampers must be supported independently of the fire barrier. HVCA or ASFP publications may be helpful.

Access through barriers

Where regular access is required through the barriers for maintenance purposes etc, this should be achieved by the inclusion of an independently supported fire rated door set and frame. The Fire Barriers should be clamped to the door frame with the RW clamping plate and appropriate fixings at 450mm centres.

Figure 31





ROCKWOOL ancillaries

ROCKWOOL Fire Barrier support angle and clamping plate are specially manufactured for ROCKWOOL.

Clamping Plate:

3m x 40mm, 10 lengths per pack

Fire Barrier Support Angles:

3m x 34mm x 75mm, 10 lengths per pack

Proprietary fixings

All steel hammer set expansion anchors for soffit fixings are available from Hilti, or Ejot. For perimeter fixings to concrete or masonry, use Hilti HUS Universal Screw system. For fixings to timber, use standard No. 10 steel wood screws 100mm long.

Durability

For durability, we recommend that the finish should be capable of withstanding at least 200 hours salt spray and 400 hours humidity corrosion resistance testing to BS 3990: Part F. Slotted angles and straps conforming to this specification are available from the following suppliers: JB Products Tel: 01384 240234 Link 51 Tel: 01952 682251 Romstor Tel: 01442 242261

If other hardware is used to support the barriers, we recommend that the respective specifier, supplier or installer should be certain that the chosen fixing system has been both tested and approved, for the required period of fire resistance and drop height.

Packaging of Fire Barrier

Shrink wrapped in polyethylene

Handling

ROCKWOOL Fire Barriers are easy to handle. It is easy to cut to any shape. The product should be stored indoors or under a weatherproof covering.

Maintenance

Once installed ROCKWOOL Fire Barriers should need no maintenance. Fire Barriers should be inspected to ensure that they have not been disturbed during maintenance of areas and/or as part of a regular maintenance program.

SPECIFICATION CLAUSES

ROCKWOOL Fire Barrier System is associated with the following NBS clauses:

K10: Gypsum board dry linings/partitions/ceilings

530 – Cavity fire barriers within partitions/wall linings

545 – Cavity fire barriers within suspended ceilings

KK40: Demountable suspended ceilings

287 – cavity barriers

425 – Installing cavity barriers

431 – Installing sound barriers

P10: Sundry insulation/proofing work

410 – Flexible cavity barriers

430 – Wired mineral wool small cavity barriers

440 – Fire protection





FirePro Fire Barrier Slab

Preventing the spread of fire and inhibiting the passage of smoke in concealed spaces



ROCKWOOL Fire Barrier Slab comprises a high density stone wool core which is foil-faced on both sides. Fire Barrier Slab has been developed to prevent the spread of flames, inhibit heat and smoke through concealed spaces in buildings and improve sound reduction.

- Simple, butt-jointed and friction fit application
- No fixings, fasteners or angles required
- Suitable for closing voids of up to 1m in height and 20m in length
- Provides airborne sound reduction
- Service penetration data available
- Fire resistance of up to 4 hours integrity
- LUL approved in combination with ROCKWOOL LUL Intumescent Sealant

ROCKWOOL Fire Barrier Slab offers labour-saving solutions to prevent fire and inhibit the spread of smoke within roof and ceiling voids.

APPLICATIONS

- Head of wall
- Concealed voids
- Service penetrations

**Subject to the application*

PERFORMANCE

Fire performance

Achieves 240min integrity; 60 min insulation without service penetrations. Where service penetrations are present Fire Barrier Slab can achieve 90min integrity; 60min insulation dependent on service penetration type. For further information of specific service penetration details please contact ROCKWOOL Technical Support.

Acoustic performance

ROCKWOOL Fire Barrier Slab has been tested in accordance with BS EN ISO 10140-2:2010 achieving Rw 23dB. Test Report N° C/23667/T01.

PRODUCT INFORMATION

Property	Description
Length	1000mm
Width	666mm
Thickness	100mm

STANDARDS AND APPROVALS

Certificate
Fire Barrier Slab has been independently tested and assessed to BS 476: Part 20 and Part 22 by accredited laboratories.
ROCKWOOL Fire Barrier system achieves a reaction to fire classification of A1 as defined in BS EN 13501:1
They are third party approved for performance and quality by the Loss Prevention Council Certification board (LPCB) and are listed in their Fire and Security 'Red Book' - certificate no. 022c.
The product has been authorised for use in LUL surface and sub-surface premises when installed in accordance with this data sheet - please refer to the LUL Approved Product Register website www.LU-apr.co.uk for specific details – LUL ref: 2231.





INSTALLATION

1. Fire Barrier Slab should be cut to the appropriate height and friction fitted within the opening.
2. ROCKWOOL Acoustic Intumescent Sealant or ROCKWOOL LUL Intumescent Sealant should then be applied to both the butt joints and perimeter of the barrier seal.

Service penetrations

ROCKWOOL Fire Barrier Slab can be penetrated by steel pipes of ≤ 33 mm external diameters and steel cable trays of ≤ 305 mm x 50mm.

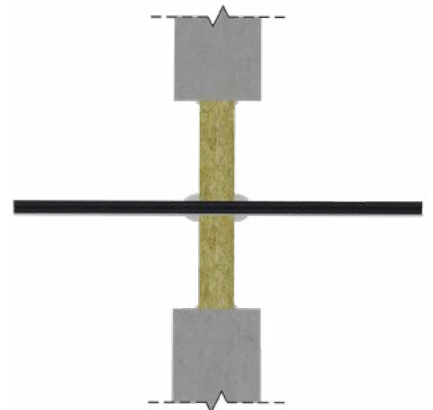
Penetrating services must be independently supported by a maximum of 150mm from the face of the slabs.

Handling

ROCKWOOL Fire Barrier Slab is easy to handle. It is easy to cut to any shape. The product should be stored indoors or under a weatherproof covering.

Maintenance

Once installed ROCKWOOL Fire Barrier Slab should need no maintenance. Fire Barrier Slab should be inspected to ensure that they have not been disturbed during maintenance of areas and/or as part of a regular maintenance program.



SPECIFICATION CLAUSES

ROCKWOOL Fire Barrier Slab is associated with the following NBS clauses:

K10 Gypsum board dry linings/partitions/ceilings

530 Cavity fire barriers within partitions/wall linings

545 Cavity fire barriers within suspended ceilings

K40 Demountable suspended ceilings

287 Cavity Barriers

425 Installing cavity barriers

431 Installing sound barriers

P10 Sundry insulation/proofing work

410 Flexible cavity barriers

430 Wired mineral wool small cavity barriers

440 Fire protection





FirePro TCB & PWCB Cavity Barriers

Fire Protection for timber/steel frame & masonry cavity walls



ROCKWOOL TCB & PWCB cavity barriers are manufactured from non-combustible stone wool, encapsulated within a resilient polythene sleeve which eliminates the need for weather protection during installation. The sleeves are also colour-coded to differentiate between the two products, TCB's being red and PWCB's white.

- Easy to install
- Fire resistance up to 60 minutes (EI)
- Reduce acoustic flanking transmission
- Improves air leakage & heat loss
- Unaffected by building movement
- Suitable for vertical and horizontal applications
- Site durable & weather protected

Preventing fire spreading through concealed voids is essential for improving safety and property protection.

One of the best ways to achieve this is to correctly specify and install cavity barriers.

APPLICATIONS

ROCKWOOL TCB & PWCB Cavity barriers can be used in both vertical and horizontal applications, providing an effective fire, acoustic and thermal barrier within external wall cavities and separating party walls.

All ROCKWOOL Cavity barriers are 1200mm long and are designed to be compression fitted within the cavity (min 10mm-15mm compression). The barriers do not rely on the polythene flanges to hold them in place in the event of a fire. It is essential that the correct cavity barrier size is specified to suit the as-built cavity width. TCB & PWCB cavity barriers are available in a range of thicknesses to suit cavity widths (refer to the tables at the end of the data sheet for more information).

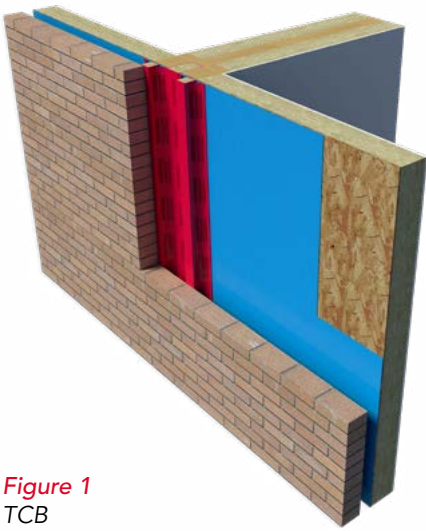


Figure 1
TCB

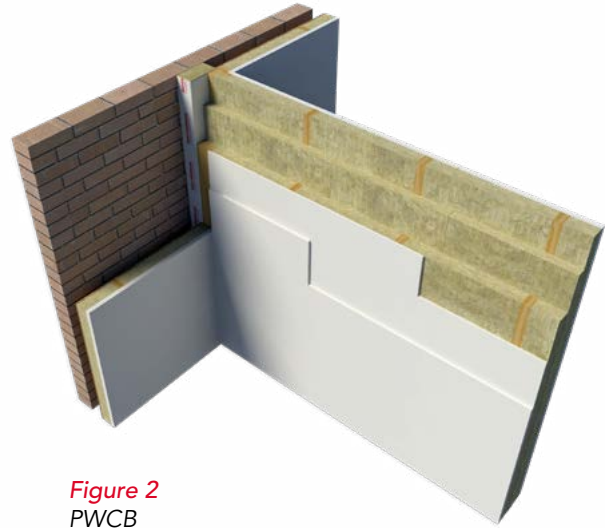


Figure 2
PWCB

PERFORMANCE

Fire performance

The use of ROCKWOOL Cavity Barriers satisfies the requirements of:

- Approved Document B (Domestic) B3 - Section 6: Concealed spaces (Cavities)
- Approved Document B (Non-domestic) B3 - Section 9: Concealed spaces (Cavities)
- Scottish Technical Handbook Section 2 - Fire Section 2.4: Cavities
- NI Technical Booklet E - Section 3: Provision of cavity barriers.

ROCKWOOL TCB & PWCB Cavity Barriers are tested and assessed to BS 476: Part 20:1987 to provide up to 60 minutes Integrity and 60 minutes insulation (Table 1 & 2)

ROCKWOOL TCB Cavity Barriers are tested to BS EN 1366-4:2006 +A1 2010 to provide up to 180 minutes Integrity and 90 minutes insulation when installed vertically and horizontally (Table 3 & 4)

Table 1 PWCB - based on data from BS 476: Part 20: 1987

Cavity width (mm)	PWCB size (mm)	Fire resistance per construction
50-55	200x65	60min integrity / 60min insulation
75-80	200x90	60min integrity / 60min insulation
90-100	200x110	60min integrity / 60min insulation
101-110	200x120	60min integrity / 60min insulation
111-120	200x130	60min integrity / 60min insulation
121-130	200x140	60min integrity / 60min insulation
131-140	200x150	60min integrity / 60min insulation
141-150	200x160	60min integrity / 60min insulation

Table 2 TCB - based on data from BS 476: Part 20: 1987

Cavity width (mm)	TCB size (mm)	Fire resistance per construction	
		Timber to timber	Masonry to masonry
50-55	65x65	30min integrity / 30min insulation	60min integrity / 30min insulation
56-65	75x75	60min integrity / 30min insulation	60min integrity / 30min insulation
75-80	90x90	60min integrity / 30min insulation	60min integrity / 60min insulation
90-100	110x110	60min integrity / 60min insulation	60min integrity / 60min insulation
101-110	120x120	60min integrity / 60min insulation	60min integrity / 60min insulation
111-120	130x130	60min integrity / 60min insulation	60min integrity / 60min insulation
121-130	140x140	60min integrity / 60min insulation	60min integrity / 60min insulation
131-140	150x150	60min integrity / 60min insulation	60min integrity / 60min insulation
141-150	160x160	60min integrity / 60min insulation	60min integrity / 60min insulation



Table 3 Wall - based on data from BS EN 1366-4: 2006 +A1 2010 (TCB only)

Cavity size (mm)	TCB range (mm)	Masonry to masonry (mins)	Masonry to steel (mins)	Masonry to timber (mins)	Masonry to ROCKWOOL (100Kg/m ³) (mins)
50-285	Min: 65x150 Max: 300x150	Integrity: 60 Insulation: 30	Integrity: 180 Insulation: 30	Integrity: 45 Insulation: 45	Integrity: 120 Insulation: 20

Table 4 Floor - based on data from BS EN 1366-4: 2006 +A1 2010 (TCB only)

Cavity size (mm)	TCB range (mm)	Masonry to masonry (mins)	Masonry to steel (mins)	Masonry to timber (mins)
50-285	Min: 65x150 Max: 300x150	Integrity: 120 Insulation: 90	Integrity: 120 Insulation: 20	Integrity: 60 Insulation: 20

PWCB cavity barrier - All ROCKWOOL PWCB's are 200mm wide, and are specifically designed for use at party wall/ external wall cavity junctions. PWCB's also achieve the requirements for fire safety, acoustic flanking and thermal bypass in one single product.

Thermal: party wall thermal bypass - PWCB meets the requirements for an effective party wall perimeter edge seal, by restricting air flow around the exposed edges of party wall cavities.

Fire: acts as an effective cavity barrier - PWCB is non-combustible and exceeds minimum fire resistance requirements for cavity barriers as set out within the Building Regulations.

Acoustic - ROCKWOOL PWCB provides an excellent acoustic absorber by reducing flanking transmission between adjoining properties, (as required by Approved Document E and Robust details).

If installed correctly, ROCKWOOL PWCB will help minimise the thermal party wall bypass effect, by restricting air leakage and heat loss between the party wall cavity and the external cavity.

Thermal bypass effect - Approved Documents L1A & L2 A of England and Wales's Building Regulations and Section 6 of Scotland's Building standards (domestic), have recognised that considerable heat loss can occur where party wall cavities interface with external cavity walls. A key feature of a SAP calculation is that Building Regulations now assign a U-value of 0.5 W/m²K to be taken for a separating party wall cavity unless specific action is taken to improve its performance.

Ways to limit heat Loss - Perimeter edge sealing only: Thermal regulations allow a U-value of 0.20W/m²K to be claimed when effective perimeter edge sealing is used around all exposed edges of the party wall.

Perimeter edge sealing plus fully filling the party wall cavity - A U-value of zero can be claimed if the party wall cavity is fully filled with appropriate mineral wool insulation, and effective perimeter edge sealing is provided around all exposed edges.

Acoustic performance

ROCKWOOL TCB & PWCB Cavity Barriers comply with the generic description for cavity closers to prevent flanking noise transmission, along concealed cavities in both external and separating walls.

Table 5

Cavity type in party wall	U-value claim for SAP
Unfilled cavity with no effective edge sealing	0.5 W/m ² K
Unfilled cavity with effective edge sealing only	0.20 W/m ² K
Fully filled cavity and effective edge sealing	0.00 W/m ² K

PRODUCT INFORMATION

Property	Description
Length	1200mm
Width	TCB – Up to 150mm / PWCB – 200mm
Thickness	TCB – Up to 300mm / PWCB – Up to 160mm
Cavity sizes	TCB – Up to 285mm / PWCB – Up to 150mm
Reaction to fire	Euroclass A1 (ROCKWOOL Core)
Fire resistance	Up to EI 60 when tested to BS 476: Part20: 1987 / Up to EI 180/90 when tested to BS EN 1366-4: 2006 +A1 2010

STANDARDS AND APPROVALS

Certificate
TCB & PWCB Cavity Barriers have been tested and assessed BS476: Part 20: 1987 and can achieve a fire resistance rating of up to 60 minutes (EI).
TCB Cavity Barriers have been tested to BS EN 1366-4: 2006 +A1 2010 using the general principles of BS EN 1363-1:2012 achieving a fire resistance rating of up to 60 minutes (EI).
TCB & PWCB Cavity Barriers are manufactured using non-combustible stone wool which is classified A1 in accordance with BS EN 13501-1: 2007 +A1 2009.
TCB Cavity Barrier tested to BS EN 1366-4 are 3rd party approved with Certifire ref: CF 5861



INSTALLATION

All joints between adjacent cavity barriers and intersections should be closely butted to ensure that a continuous fire seal is maintained.

In vertical applications, both flanges of the Cavity Barrier can be fixed to the inner leaf at 150mm centres, using staples or clout nails prior to compression fitting by outer cavity wall.

In horizontal applications, only the top flange of the polythene sleeve should be fixed.

Fully filled cavities in external walls

Where the external wall cavity is fully filled external cavity barriers are generally not required in the outer wall.

Partially filled cavities in external walls

Where partial fill insulation is used in the external wall, the insulation should be cut back to permit the cavity barrier to be compression fitted between the inner and outer leaves. The head of the cavity wall should be closed at eaves level with the ROCKWOOL TCB Cavity Barrier.

SPECIFICATION CLAUSES

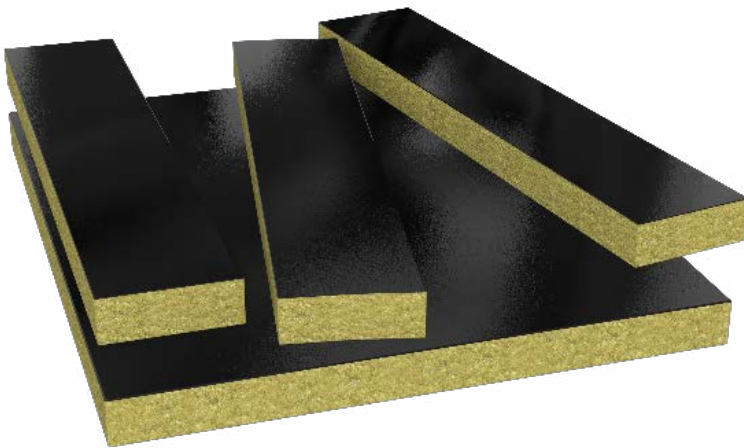
ROCKWOOL TCB & PWCB Cavity Barriers are associated with the following NBS specification clauses:

F30 Accessories/sundry items for brick/block stone walling
180 Cavity Closers
K10 Gypsum board dry linings/partitions/ceilings
530 Cavity barriers within partitions/wall linings
P10 Sundry insulation/proofing work
420 Sleeved mineral wool small cavity barriers



FirePro[®] SP FireStop EN

The purpose-made solution for cavity fire stopping



FirePro SP FireStop EN comprises of both the SP FireStop EN Slab and SP FireStop fixing brackets. SP Slabs incorporate a black foil facing to both sides which helps to resist the passage of smoke.

- Easy to install, dry fit system
- Tested with an SFS substrate both horizontally and vertically
- Tested to the latest BS EN 1366-4: 2021 standard for up to EI 120*
- Tested in a full scale furnace with large joint widths of 2600mm
- Resists the passage of smoke - black aluminium foil on both sides

*Subject to application

SP FireStop EN Slab has been specifically designed to form cavity fire stops within buildings.

APPLICATIONS

SP FireStop EN may be installed horizontally or vertically and is suitable for cavity widths between 50mm and 600mm.*

SP FireStop EN has been tested with the following substrates:

- Masonry/concrete to masonry/concrete
- SFS to masonry/concrete
- Masonry concrete to composite panel (stone wool core)

SP FireStop EN is not suitable for use as a horizontal fire barrier in ventilated façade systems. For these applications consider using ROCKWOOL SP FireStop OSCB.

*Subject to application

PERFORMANCE

Fire performance

SP FireStop EN has been tested in accordance with BS EN 1366-4:2021; Fire resistance test for service installations. Linear joint seals. SP FireStop EN can provide up to EI 120 in cavities up to 600mm.*

*Subject to application

Use the link below to access further information on fire performance:

[UL Classification report: 4790634702-01](#)

Acoustic performance

ROCKWOOL products have acoustic properties and can reduce the levels of airborne sound transmission through wall and floor cavities. For further information please contact ROCKWOOL Technical Support.

PRODUCT INFORMATION

Property	Description
Length	1000mm
Width	1200mm
Thickness	SP FireStop EN 60: 75mm SP FireStop EN 120: 90mm
Facing	Black aluminium foil
Fire resistance	Up to EI120*

*Subject to application

STANDARDS AND APPROVALS

Certificate
SP FireStop EN has been tested in accordance with BS EN 1366-4: 2021 and classified to BS EN 13501-2.



INSTALLATION

ROCKWOOL SP FireStop EN Slabs are designed for cutting on-site with an insulation knife or fine toothed saw and a straight edge. The cavity to be fire stopped should be measured and the slab cut to suit this dimension (allowing for 10mm compression), using one piece only per gap width - see Figure 1.

For easy compression fitting and to accommodate the fixing pattern, cutting should be along the 1000mm length as indicated in figure 1. The SP Fixing Brackets are then re-profiled by hand and cut as necessary to allow at least 75% penetration of the fire stop material – see Figures 2 to 5.

Figure 1
Cutting method for SP FireStop EN Slab

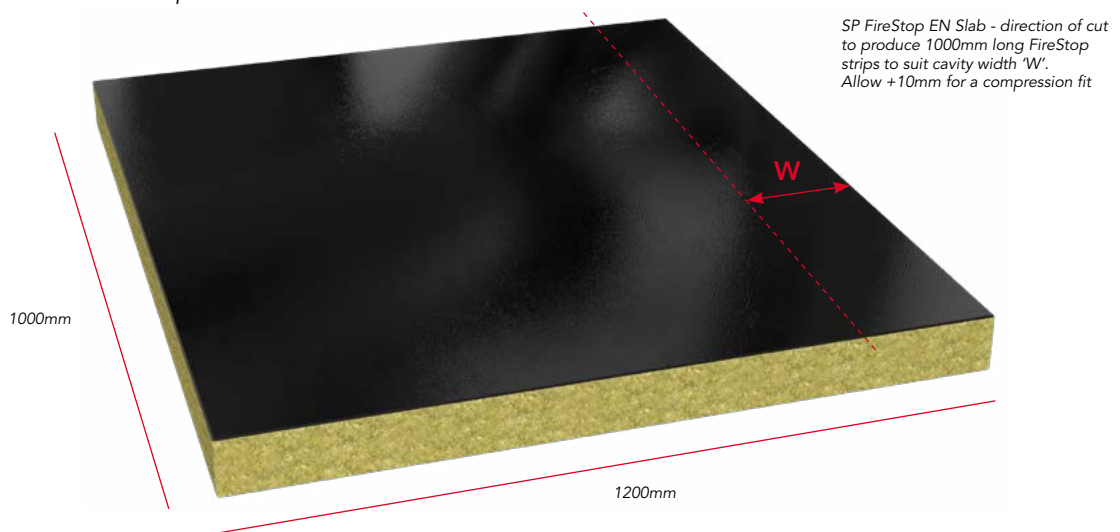


Figure 2
SP FireStop EN fixing bracket

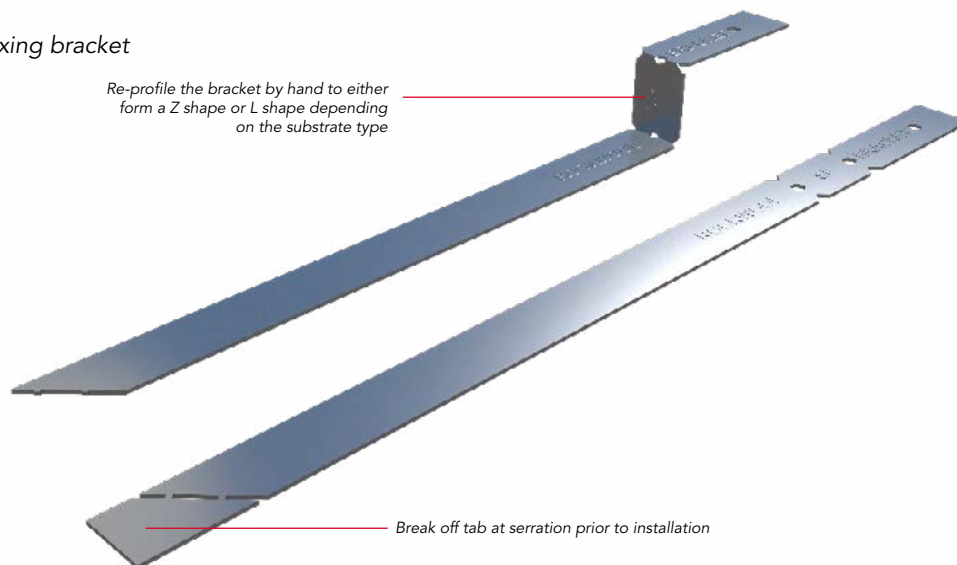


Figure 3
SP FireStop EN fixed to concrete floor slab

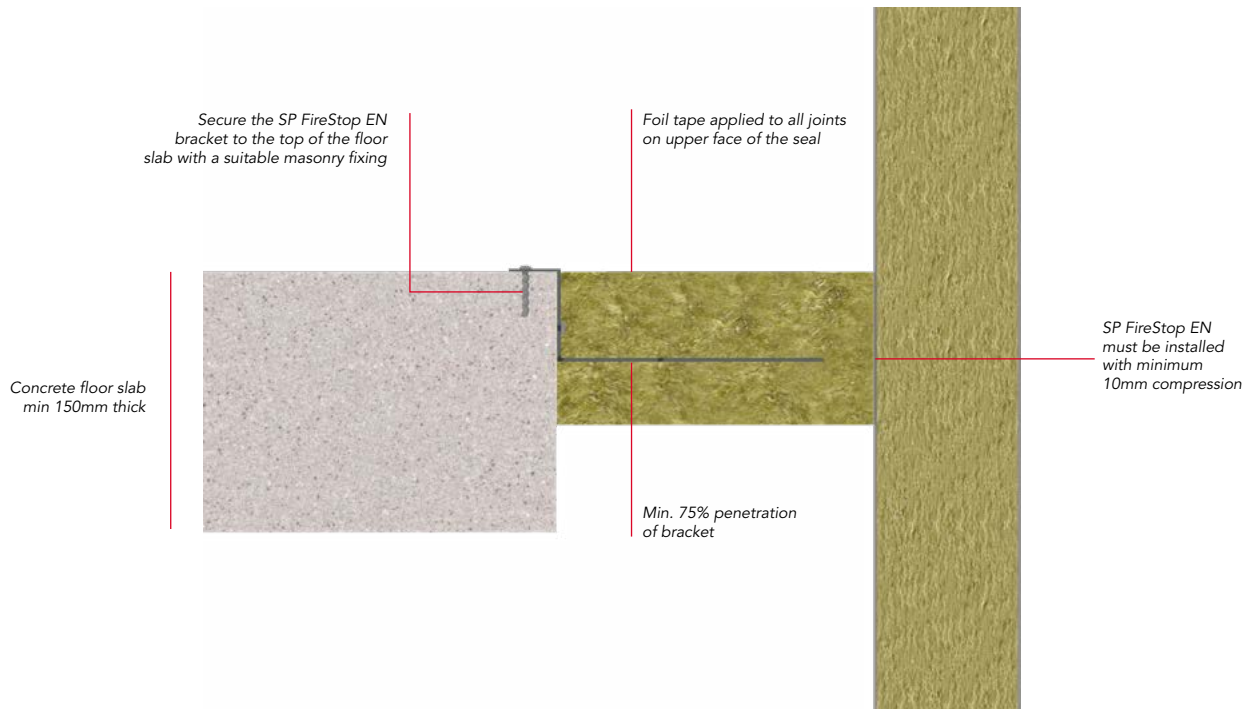
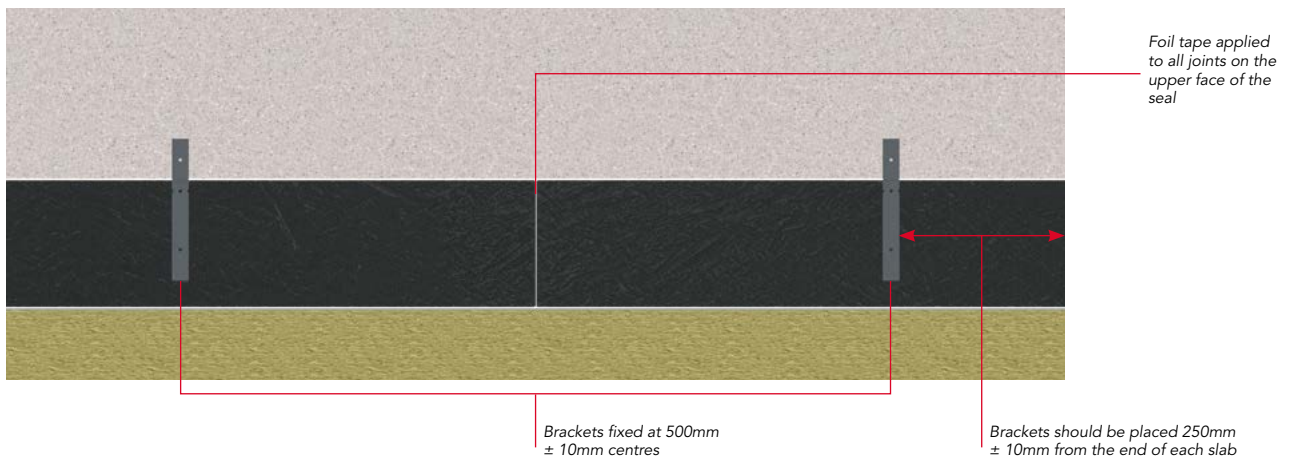


Figure 4
Plan view





Fixing SP FireStop EN

1. Cut a strip of SP FireStop EN Slab to suit the cavity size, allowing an additional 10mm to ensure a compressive fit (Figure 1).
2. Insert two appropriately re-profiled SP Fixing Brackets into the cut strip at 500mm centres / 250mm \pm 10mm from each end (Figure 2).
3. Fit the bracket-impaled strip into the cavity, ensuring a secure fit within the void and tight abutment between adjacent strips.
4. Secure the SP Fixing Brackets to the substrate using metal fixings appropriate to the substrate (Figures 3 to 6).
5. a) Horizontal orientation: Foil tape should be applied to all joints on the upper face of the SP FireStop EN strips (Figure 3).
b) Vertical orientation: Foil tape should be applied to all joints on both sides of the SP FireStop EN strips.
6. If installing between masonry and sheathing board, measures should be considered to prevent moisture tracking across the cavity.

Figure 5
SP FireStop EN horizontally fixed to SFS system

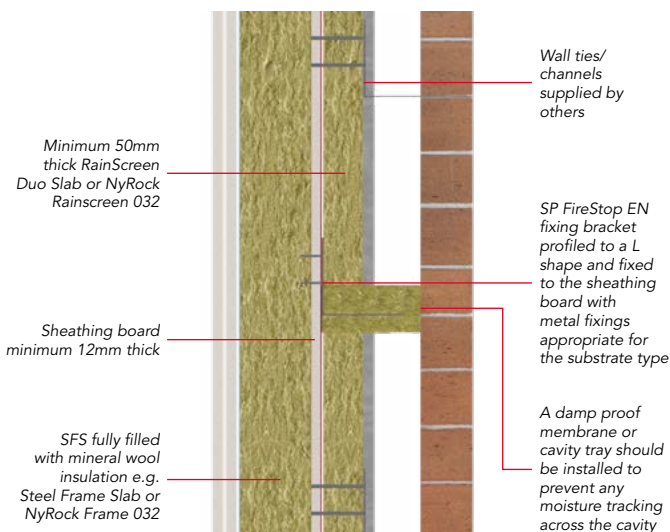
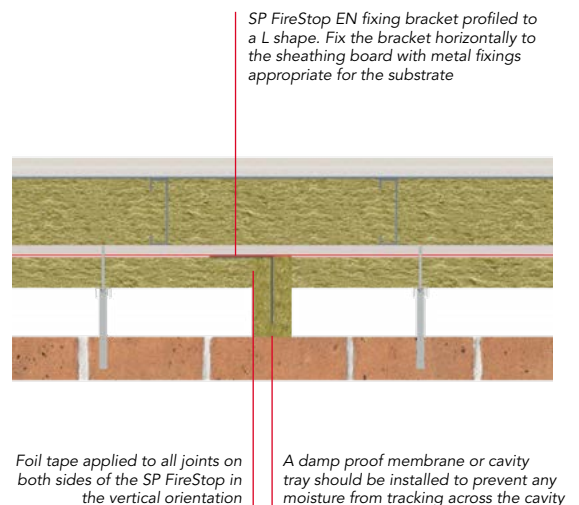


Figure 6
SP FireStop EN horizontally fixed to SFS system



While the external wall itself does not typically require a fire resistance performance, this is not the case for abutting compartment walls and floors; as such SP FireStop EN has been tested within representative wall and floor substrates to prove their fire resistance performance. It is important to note that the fire resistance performance of a firestop is only as good as the performance of the supporting substrates in to which it is installed. Where fire-stopping is installed up to a non-fire resisting external wall then the performance of the firestop will be limited to the performance of the wall itself.

HANDLING

SP FireStop EN Slabs are light and easy to handle. They are supplied as slabs on pallets and protected with a polyethylene hood, which will provide short term protection. For long term storage they must be protected by a waterproof covering.

ANCILLIARIES

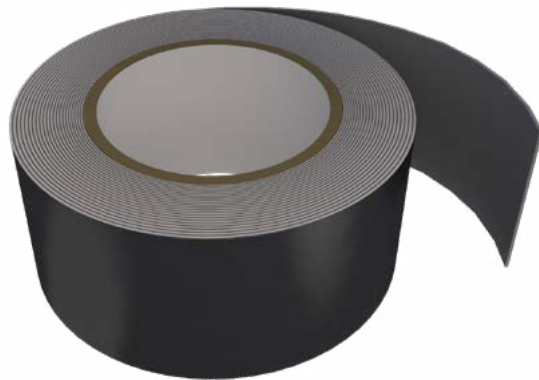
SP FireStop Fixing Brackets

Bracket type	Max. cavity size (mm)	Pieces / pack
SP/S	100	50
SP/L	400	50
SP/XL	600	50

SP Fixing Brackets are supplied in three standard sizes; SP/S (small), SP/L (large) and SP/XL for cavity widths up to 600mm. The brackets are supplied in cardboard boxes of 50 pieces, flat packed and designed to be easily re-profiled by hand on site. The SP Fixing Brackets should be cut on site as necessary to allow at least 75% penetration of the firestop. In order to comply with fire test certification, only ROCKWOOL SP Fixing Brackets can be used to install the product.

Black ALU Foil Tape

FirePro Black Foil Tape is available through ROCKWOOL stockists.



SPECIFICATION CLAUSES

The SP FireStop System is associated with the following NBS specification clauses:

F30 Accessories/sundry items for brick/block stone walling
180 Cavity Closers
P10 Sundry insulation/proofing work
432 Cavity Barriers
P12 Firestopping systems
360 Mineral Wool Rigid Batts

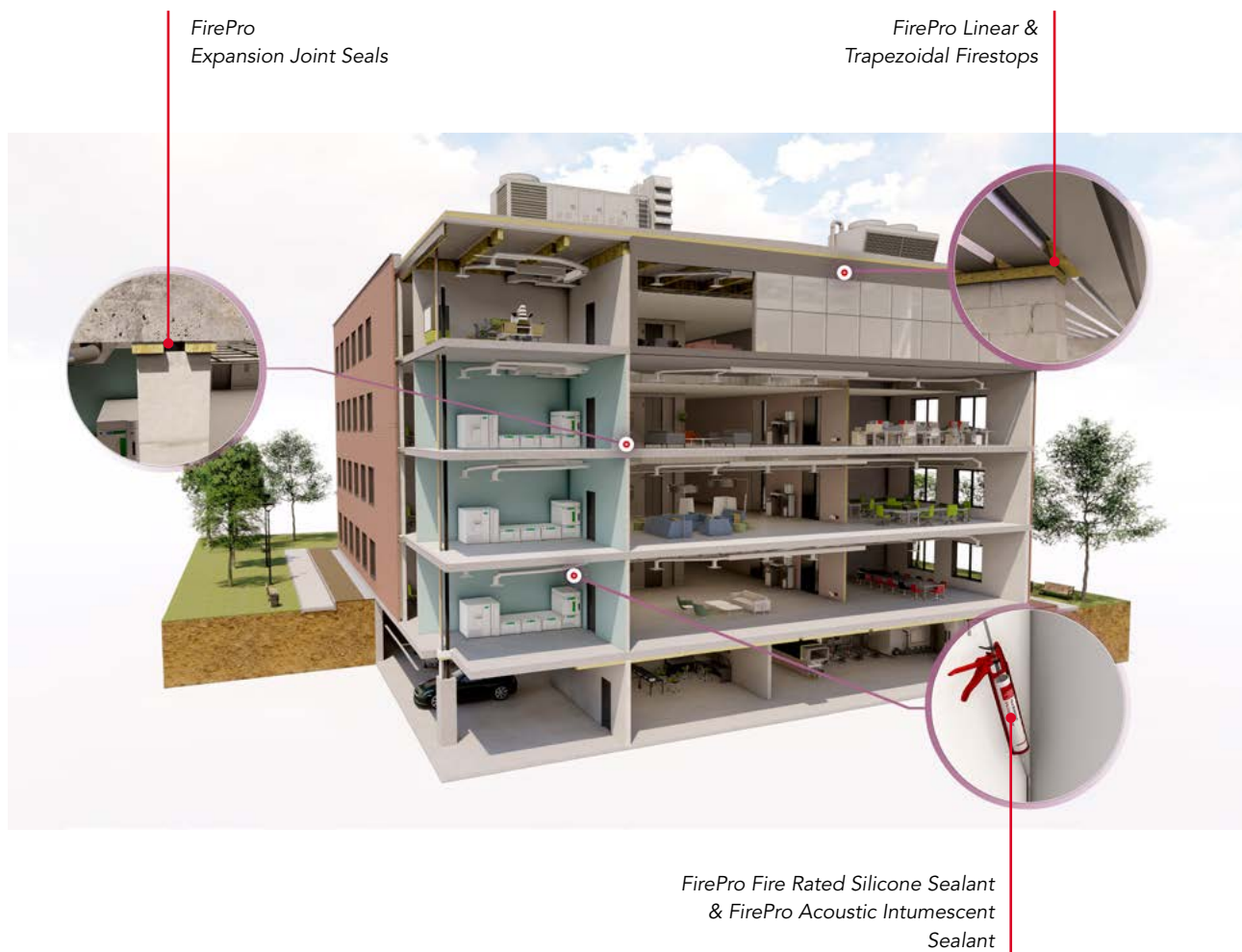


Section 3: Linear joint seals

Sealing construction joints between fire resistance elements within a compartment is vital. Products and systems used in this application should achieve the same level of fire resistance as the compartment elements, whilst also maintaining integrity during the expansion and contraction (movement) of construction materials.

ROCKWOOL provide a range of tested products that are designed for sealing linear joints between different construction materials, that can also accommodate movement where required. Within our product range there are products suitable for:

- Fire stopping junctions between compartments walls and floors or roof decks
- Fire stopping expansion joints within the construction
- Sealing narrow joints between different substrates



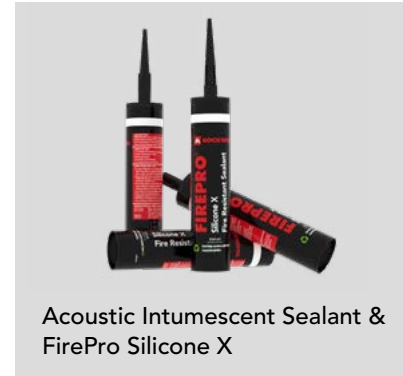
Core products



Linear & Trapezoidal Firestops



FirePro SoftSeal System



Acoustic Intumescent Sealant & FirePro Silicone X

Useful documents and standards

ASFP Technical Guidance Document – TGD 17: Code of practice for the installation and inspection of fire stopping systems in buildings

ASFP Red Book: Fire stopping and penetration seals for the construction industry

ASFP: Ensuring best practice for passive fire protection in buildings

ASFP: On-site guide to installing fire stopping

BS 476-20: Fire test on building materials and structures. Method for determination of the fire resistance of elements of construction

BS EN 1366-4: Fire resistance test for service installations. Linear joint seals

BS EN 1363-1: Fire resistance tests. General Requirements

BS EN 13501-2: Fire classification of construction products and building elements. Classification using test data from resistance to fire tests, excluding ventilation services.

BS EN 13501-2: Fire classification of construction products and building elements.

Classification using test data from resistance to fire tests, excluding ventilation services.

ASFP (Association for Specialist Fire Protection) guidance documents can be sourced at www.asfp.org.uk



FirePro SoftSeal System Penetration Seals

Flexible firestopping for service applications



Part of the ROCKWOOL FirePro range, FirePro SoftSeal System incorporates a product specifically designed to accommodate movement within buildings in penetration seals.

- Acoustically absorbent
- CE Marked
- Easy to handle and install
- Tested for durability to current EU guidelines
- Supplied pre-coated

The ROCKWOOL FirePro SoftSeal System has been developed in response to demand from the market for a firestopping solution where high levels of movement in the building's services or joints need to be accommodated.

The FirePro SoftSeal System is suitable for applications in penetration seals.

APPLICATIONS

As part of the comprehensive ROCKWOOL FirePro range of fire protection products, FirePro SoftSeal System incorporates a product specifically designed to apply to penetration seals within buildings, where the design needs to accommodate movement in the services.

The FirePro SoftSeal System can be installed into apertures within concrete floors, masonry walls, dry wall systems or composite panels*, or as a standalone seal for openings up to 1000mm x 1000mm or as part of a larger ROCKWOOL Ablative Coated Batt seal (2 layers) to accommodate movement of services.**

A FirePro SoftSeal Coated Strip comprises a low-density stone wool SoftSeal Lamella Strip, pre-coated with SoftSeal Flexible Coating.

The FirePro SoftSeal Coated Strip is supplied in strips 1200mm x 200mm x 100mm.

The FirePro SoftSeal flexible Coating is also available in 5L, 10L and 20L tubs to enable site repairs to FirePro SoftSeal Coated Strips and FirePro SoftSeal Linear Joint Seals, that may have been damaged during installation.

To complement the FirePro SoftSeal Coated Strip, ROCKWOOL also supplies FirePro SoftSeal High Expansion Intumescent Sealant (310ml) and FirePro SoftSeal Flexible Acoustic Intumescent Sealant (310ml).

FirePro SoftSeal Coated Strip is intended to reinstate the fire resistance, acoustic and air seal performances of concrete floors, masonry walls, dry wall systems and composite panels when voids have been created for the passage of services. This includes pipes made of steel, cast iron, copper, polypropylene (PP), high density polythene (HDPE), PVC and ABS along with all sheathed cables up to 80mm and supported cable bundles up to 100mm.

**For further information on the specific composite panels tested, please use the links under the heading Fire Performance, to assessments UL 4790145104 and UL 4790921776.*

***Higher levels of service movement may be accommodated by installing the product under higher compression rates, please contact ROCKWOOL Technical Solutions for guidance.*

PERFORMANCE

Fire performance

ROCKWOOL FirePro SoftSeal Coated Strip has been tested to the dedicated fire resistance standard for penetration seals BS EN1366-3 and shown to provide up to 2 hours* fire performance (EI20). **Subject to the application*

SoftSeal Coated Strip has been CE marked to EAD 350454-00-1104.

Use the links below to access further information on fire performance

[UL 4790145104](#)

[UL 4790921776](#)

[ETA 20-1124](#)

[Certificate of constancy of performance - 2531-CPR-CXO10260](#)

[Fire stopping standard details pack](#)

Acoustic performance

- Tested to EN 10140 with the following results:
- Rw 30 dB: When installed with 100mm thick SoftSeal Batt
- Dn,e,w 40 dB: When installed with 100mm thick SoftSeal Batt

Water permeability

- Tested to EN 1027 - No leakage observed up to 300Pa.

Air permeability

- Tested to EN 1026 up to 600Pa.
- Leakage at 50Pa - 0.1/1.4 m³/m²/h.

PRODUCT INFORMATION

Property	Description
Length	1200mm
Width	200mm
Thickness	100mm
Fire resistance	Up to 2 hours*
Coating	2 sides
Density	80kg/m ³

**Subject to the application*

STANDARDS AND APPROVALS

Certificate
FirePro SoftSeal has been tested and assessed to BS EN1366-3 2009 and classified to EN 13501-2.
CE marked to EAD 350454-00-1104





INSTALLATION

1. Measure the height of the aperture to be sealed.
2. Cut the FirePro SoftSeal Coated Strips 15% bigger than the height of the void to be filled, so when installed they are under compression.
3. Ensure substrate is clean and free of dust and debris.
4. Apply a bead of FirePro SoftSeal Acoustic Intumescent Sealant around the internal edges of the aperture.
5. Install the FirePro SoftSeal Coated Strips horizontally, so that the lamellas are running horizontally.
6. Apply a bead of FirePro SoftSeal Acoustic Intumescent Sealant to butt joints between different sections of SoftSeal Coated Strip and around services.
7. FirePro SoftSeal High Expansion Intumescent Sealant shall be used around plastic pipes in accordance with ROCKWOOL standard details.
8. Apply FirePro SoftSeal Flexible Coating to the face of all joints between SoftSeal Coated Strip and substrate/ Ablative Coated Batt.
9. Once installed, apply a second coat of SoftSeal Flexible Coating to the surfaces on both sides of the seal.

N.B. Ensure adequate space above and below services to accommodate the FirePro SoftSeal product, for the movement levels required. Please refer to assessments UL 4790145104 and UL 4790921776 for specific information on framed apertures within composite wall panels.



Penetration seals

SPECIFICATION CLAUSES

FirePro SoftSeal System is associated with the following NBS clauses:

P12 Fire stopping systems

160 – Linear gap sealing

FirePro SoftSeal System Linear Joint Seals

Flexible firestopping for joint applications



Part of the ROCKWOOL FirePro range, FirePro SoftSeal System incorporates a product specifically designed to accommodate movement within buildings in linear joint seals.

- Acoustically absorbent
- CE Marked
- Easy to handle and install
- Both vertical and horizontal joint applications
- Tested for durability to current EU guidelines
- Supplied pre-coated

The ROCKWOOL FirePro SoftSeal System has been developed in response to demand from the market for a firestopping solution where high levels of movement in the building's services or joints need to be accommodated.

The FirePro SoftSeal System is suitable for applications in linear joint seals.

APPLICATIONS

As part of the comprehensive FirePro range of fire protection products, ROCKWOOL FirePro SoftSeal System incorporates a product specifically designed to form a linear joint seal within buildings, where the design needs to accommodate movement in the joint.

It may be installed horizontally or vertically and is suitable for linear joint widths up to 200mm*. FirePro SoftSeal Linear Joint Seal can also be used as a 'head-of-wall' barrier to extend the fire resistance and acoustic performances of masonry walls that finish at suspended ceiling height, up to the concrete soffit above. FirePro SoftSeal Linear Joint Seal can be used in conjunction with ROCKWOOL Ablative Coated Batt for head-of-wall applications.

A FirePro SoftSeal Linear Joint seal comprises a low-density stone wool FirePro SoftSeal batt, pre-coated with FirePro SoftSeal Flexible Coating. Depending on the application, FirePro SoftSeal Linear Joint Seal can be supplied on either one or both sides. (Single Sided for Horizontal Applications. Double sided for Vertical Applications).

The FirePro SoftSeal Flexible Coating is also available in 5L, 10L and 20L tubs to enable site repairs to FirePro SoftSeal Coated Strips and FirePro SoftSeal Linear Joint Seals, that may have been damaged during installation.

The FirePro SoftSeal Linear Joint Seal is supplied in strips 1200mm x 200mm x 100mm.



PERFORMANCE

Fire performance

ROCKWOOL FirePro SoftSeal Linear Joint Seal has been tested to the dedicated fire resistance standard for linear joint seals BS EN1366-4 and shown to provide up to 4 hours* fire performance (E240 & EI80). **Subject to the application*

SoftSeal Linear Joint Seal has been certified by UL and CE marked to EAD 350141-00-1106.

Use the links below to access further information on fire performance

[UL-EU Certificate - UL-EU-01201-CPR](#)

[ETA 20-1137](#)

[Certificate of constancy of performance - 2531-CPR-CXO10268](#)

[Fire stopping standard details pack](#)

Movement

As part of the testing to BS EN 1366-4, FirePro SoftSeal was assessed for its movement capabilities, prior to conducting the fire test. The product was tested to accommodate movement (expansion and contraction) of +/-25%.

Acoustics

- Tested to EN 10140 based on two thicknesses with the following results:
- Rw 30 dB: When installed with 100mm thick SoftSeal Batt
- Rw 39 dB: When installed with 200mm thick SoftSeal Batt
- Dn,e,w 40 dB: When installed with 100mm thick SoftSeal Batt
- Dn,e,w 49 dB: When installed with 200mm thick SoftSeal Batt

Water permeability

- Tested to EN 1027 - No leakage observed up to 300Pa.

Air permeability

- Tested to EN 1026 up to 600Pa.
- Leakage at 50Pa - 0.1/1.4 m³/m²/h.

PRODUCT INFORMATION

Property	Description
Length	1200mm
Width	200mm
Thickness	100mm
Fire resistance	Up to 4 hours*
Coating	1 side
Density	80kg/m ³
Movement	+/-25%

**Subject to the application*

STANDARDS AND APPROVALS

Certificate
FirePro SoftSeal has been tested and assessed to BS EN1366-4: 2006 + A1: 2010 and classified to EN 13501-2.
Third party certification through UL, Certificate No. UL-EU-01201-CPR
CE marked to EAD 350141-00-1106



INSTALLATION

1. Measure the width of the Linear Joint to be sealed.
2. Cut the FirePro SoftSeal Coated Strips up to 25% bigger than the joint width, so when installed they are under compression.
3. Ensure substrate is clean and free of dust and debris.
4. Install the FirePro SoftSeal Linear Joint Seal with the coating on the top surface.
5. Apply FirePro SoftSeal Flexible Coating to the face of all joints between the seal and the substrate, overlapping by 20mm.
6. Apply FirePro SoftSeal Flexible Coating to the faces of all butt joints between pieces of Soft Seal Linear Joint Seal.



SoftSeal installed as a linear joint seal



Linear joint seals

SPECIFICATION CLAUSES

FirePro SoftSeal System is associated with the following NBS clauses:

P12 Fire stopping systems

160 – Linear gap sealing



FirePro Linear & Trapezoidal FireStop System

Fire stopping solutions at compartment junctions



Linear and Trapezoidal FireStop products are made from dense, moisture resistant stone wool, allowing adequate compression yet retaining the necessary lateral stiffness for ease of installation.

The Linear and Trapezoidal FireStop System can be manufactured to suit a wide range of steel profile dimensions.

All FireStop products are supplied in standard lengths of 1m.

- Up to 4 hours fire resistance
- Suitable for walls ranging from 400kg/m³
- Manufactured for a wide range of profiles
- Easy installation

Linear and Trapezoidal FireStop Systems have been developed to provide up to 4 hours fire stopping at the junctions of compartment walls and floors.

The systems have been tested in accordance with BS 476 part 20: 1987.

APPLICATIONS

Linear and Trapezoidal FireStop Systems have been developed to provide up to 4 hours firestopping at the junctions of compartment walls and floors. Solutions illustrated are for masonry walls with a density of at least 400 kg/m³ and include both fire integrity and insulation criteria for concrete decks, composite decks and simple profiled sheeting.

Linear FireStop 2A

- Rectangular strips (installed under min. 5% compression)
- Thicknesses: 12.5, 20, 30, 40, 50, 60, 70, 80, 90, 100mm
- Widths: 100, 150, 200, 300, 400mm
- Fire resistance: Up to 4 hours

Trapezoidal FireStop 2B

- Trapezoidal strips (tight fit required)
Available for all profiled decks. Deck profile to be named at time of order, e.g. Ribdeck 60, Alphalok etc.

Dovetail Infill FireStop Strip

- Supplied as narrow rectangular strips for pinched installation into nominated dovetail shaped deck profiles; e.g. Holorib, Quickspan, Q51



Figure 1
Linear FireStop 2A



Figure 2
Linear FireStop 2A and 2B



Figure 3
Linear FireStop 2A and Dovetail Infill Strip

PERFORMANCE

Fire performance

All fire ratings apply to gaps over walls constructed of dense aggregate blocks, lightweight aggregate concrete, clay bricks or concrete blocks with a minimum density of 400Kg/m³.

Fire resistance includes integrity and insulation criteria to BS 476: Part 20: 1987

Min. wall thickness/ fire stop width	Fire resistance (integrity and insulation)
100mm	2 hours
150mm	3 hours
200mm	4 hours
Friction fitted	600 x 600mm

Note: Stated performance assumes fire resistance of supporting wall is no less than fire stop.

PRODUCT INFORMATION

Property	Description
Length	1000mm
Width	Up to 400mm
Thickness	12.5 – 100mm
Deck Profiles	Various
Density	110 Kg/m ³
Fire Resistance	Up to 4 hours

STANDARDS AND APPROVALS

Certificate

Linear and Trapezoidal FireStop Systems are third party approved by the Loss Prevention Council Certification board (LPCB) for performance and quality and are listed in the "Red Book" - certificate no. 022b(2). Certificates can be accessed online at rockwool.com/uk or redbooklive.com

This product has been authorised for use in LUL surface and sub-surface premises when installed in accordance with this datasheet - please refer to the LUL Approved Product Register website www.LU-apr.co.uk for specific details.





INSTALLATION

The following installation requirements must be met in order to reliably achieve the stated fire resistances.

- Linear FireStop 2A must be fitted as rectangular pieces, tightly butt jointed and compressed by at least 5% in thickness.
- Up to 3 layers may be used. Single layer firestopping will always be preferred, with multi-layer methods limited to those occasions where building tolerances demand practicality. All layers should be installed simultaneously. The height of void should not exceed the width of the FireStop.
- Gaps associated with perimeter floor slab/wall fire stopping should be achieved using FirePro SP FireStop EN.

Handling/storage

Linear and Trapezoidal FireStop materials are light and easy to handle and should be cut using a sharp bladed knife. Store in dry conditions.

Maintenance

Once installed, Linear and Trapezoidal FireStop materials will need no maintenance unless disturbed.

Other information

For areas such as clean rooms, FireStop Systems are available totally enclosed in shrink wrap.





Figure 4
Profiled metal deck over blockwork wall



Figure 5
Profiled metal deck with/without concrete
over a universal beam

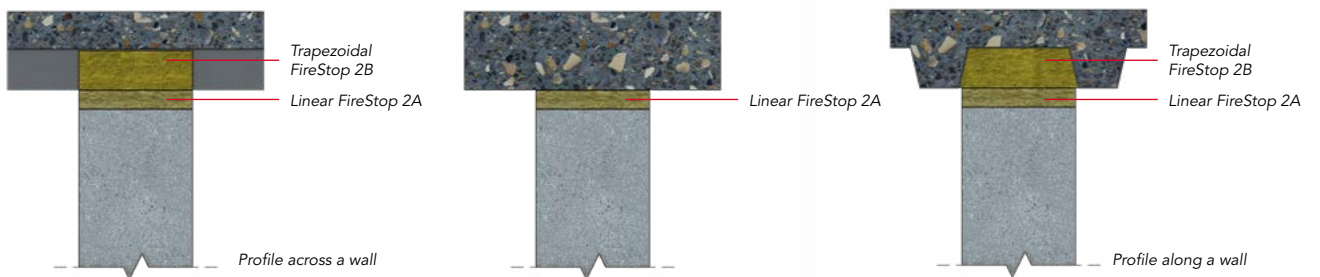


Figure 6
With/without profiled metal deck under a
lightweight concrete slab



Fire stopping: Section 3 - Linear joint seals

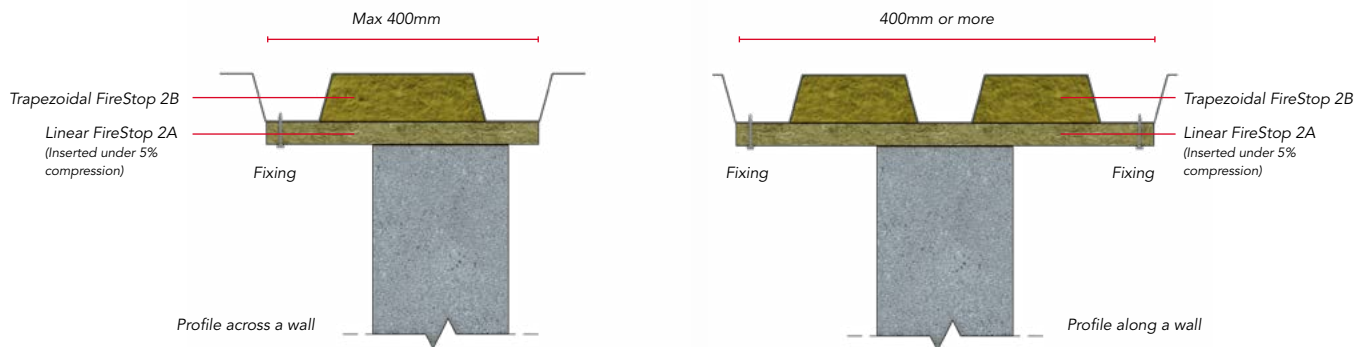


Figure 7a & 7b

Metal profiles parallel but offset from the wall line

Fig 7a: The 'overhang' of the Linear FireStop 2A should be supported with steel self-tapping screws or 'hammer fix' anchors into deck / concrete soffit at 350mm maximum centres (minimum of 3 fixings per 1m length of fire stop).

Fig 7b: Where the Linear FireStop 2A is required to be fixed to the deck at distances in excess of 400mm, turn the 1m length of fire stop 90° and cut to required size to suit profile spacing. In such cases, secure each length of fire stop to the soffit using at least 2 fixings at both ends.

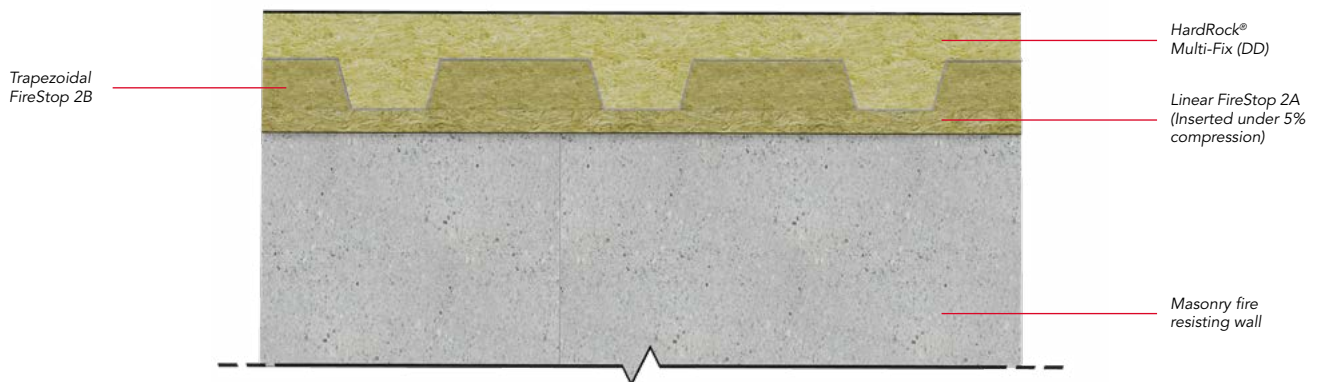


Figure 8

ROCKWOOL Insulated flat roof deck with profiles perpendicular to the wall line

When fire stopping between the head of a fire resistant wall and the underside of a perforated roof deck insulated with ROCKWOOL HardRock Multi-Fix [DD] flat roof insulation, it should be considered best practice to fill both the upper and lower deck profiles with Trapezoidal FireStop 2B products. In such cases, when placing an order it should be noted that the sizes of the two profiles may differ.

In cases where combustible thermal insulation passes over the head of a fire resisting wall, guidance on maintaining fire compartmentation is provided in Approved Document B (Volume 2, Section B3) of The England and Wales Building Regulations 2000 (2006 edition). To reduce the risk of fire spreading to an adjacent compartment in such cases, it may be necessary to extend the wall through the roof line or introduce a 'protected zone' 1500mm either side of the fire resisting wall.





FirePro Acoustic Intumescent Sealant

Fire & acoustic intumescent sealant for linear joints



Acoustic Intumescent Sealant is a high specification, one part water based acrylic sealant. Acoustic Intumescent Sealant is designed for use in the installation of ROCKWOOL Ablative Coated Batt, sealing linear joints and some individual service penetrations passing through various substrates.

- Up to 4 hours* fire protection
- Acoustically tested
- Air leakage tested
- Suitable for linear joints up to 50mm wide
- Suitable with multiple substrates and services
- Increased movement capability
- Available as a trowel grade option

ROCKWOOL FirePro Acoustic Intumescent Sealant is used to reinstate the fire resistance of wall and floor constructions where apertures are penetrated by multiple services or linear gaps.

ROCKWOOL Acoustic Intumescent Sealant is comprehensively tested, and the only product approved for use with ROCKWOOL Ablative Coated Batt.

APPLICATIONS

Acoustic Intumescent Sealant is comprehensively tested for a wide range of applications which include:

- Sealing service penetrations
- Linear joint seals
- Installation of Ablative Coated Batt

This product should NOT be allowed to come into direct contact with cPVC type piping.

*Subject to the application

PERFORMANCE

Fire performance

Acoustic Intumescent Sealant has been tested to BS EN 1366-3: 2009 and BS EN 1366-4: 2006 +A1:2010 and can provide up to 4 hours* fire protection in joints up to 30mm. **Subject to the application*

Acoustic Intumescent Sealant has been certified by UL and CE marked to EAD 350454-00-1104 and EAD 350141-00-1106

Use the links below to access further information on fire performance:

[UL-EU Certificate - UL-EU-01203-CPR >](#)

[ETA 20/1129 >](#)

[ETA 20/1130 >](#)

[Certificate of constancy of performance - 2531-CPR-CXO10266 >](#)

[Fire stopping standard details pack >](#)

Acoustic performance & air permeability

Please refer to UL Certificate: UL-EU-01203-CPR for further information on acoustic performance and air permeability.

PRODUCT INFORMATION

Property	Description
Application temperature	>5°C
Yield	up to 5.9lm
Wighted sound reduction index	up to 57dB
Fire resistance	up to 4 hours*
Shelf life	18 months

**Subject to the application*

STANDARDS AND APPROVALS

Certificate
Acoustic Intumescent Sealant has been tested to BS EN 1366-3: 2009 and BS EN 1366-4: 2006 +A1:2010 and classified to EN 13501-2, providing up to 4 hours* fire protection in joints up to 30mm. <i>*Subject to the application</i>
Acoustic Intumescent Sealant has been CE marked against EAD 350454-00-1104.
Third party certification through UL, Certificate No. UL-EU-01203-CPR.





INSTALLATION

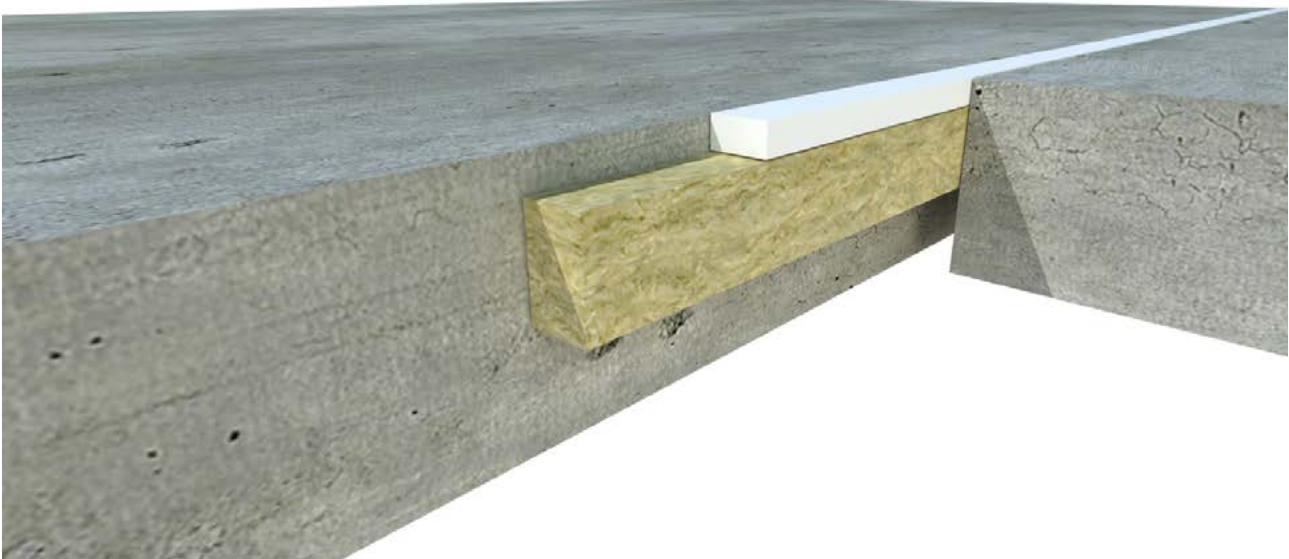
All surfaces must be thoroughly clean and free of bond breaking contaminants prior to application of the sealant. No priming is required for most commercial substrates; however, it is recommended that before installation the sealant is applied to a small area of the substrate to assess adhesion.

The sealant should not be applied if the ambient temperature is below 5°C as adhesion may be impaired.

The sealant is fast curing, approximately 15-minute tack free time. When fully cured, the sealant can be overpainted.

Each cartridge/sausage is intended to provide the following application rates:

Joint size (mm)	Depth of sealant (mm)	Yield per cartridge (m)	Yield per sausage (m)
10	10	3.10	5.90
20	15	1.03	1.95
30	20	0.51	0.95



SPECIFICATION CLAUSES

FirePro Acoustic Intumescent Sealant is associated with the following NBS clauses:

E40: Designed joints in in-situ concrete
530 Sealant
F30: Accessories/sundry items for brick/block/stone walling
610 Movement joints with sealants
L10: Windows/rooflights/screens/louvres
790 Fire resisting frames
L20: Doors/shutters/hatches
820 Sealant joints
P12 Fire stopping systems
395 Sealant-One part fire resistance acrylic




Cartridge system made from 100%
recycled plastics
Manufactured in UK
310 ml

FIREPRO[®]
Acoustic
Intumescent Sealant


ROCKWOOL



FirePro Silicone X

Fire resistant silicone sealant



Supplied in 310ml cartridges, FirePro Silicone X is a fire resistant silicone sealant designed for use as a linear joint seal within construction joints of walls and floors. Silicone X is white in colour, and once cured is a permanently flexible silicone rubber.

- Movement capability of $\leq 7.5\%$
- Suitable for internal and external use
- Can provide a cold smoke seal
- Tested with multiple substrates
- Cartridges contain 30% recycled plastic

FirePro Silicone X is a one-part neutral curing silicone.

It is designed for use as a linear joint seal within construction joints of walls and floors and where apertures are penetrated by services.

APPLICATIONS

Silicone X is suitable for linear construction joints of up to 60mm and can be used to reinstate the fire resistance of rigid floors, rigid and flexible walls.

Silicone X is suitable for use within joints formed by multiple substrates which include:

- Masonry to masonry
- Masonry to steel
- Masonry to softwood
- Masonry to hardwood
- Masonry to plasterboard

**Subject to the application*

PERFORMANCE

Fire performance

FirePro Silicone X has been tested in accordance with BS EN 1366-4:2006 and can achieve fire resistance ratings of up to 4 hours* (integrity). *Subject to the application

Silicone X has been certified by UL and CE marked to EAD 350141-00-1106.

Use the links below to access further information on fire performance:

[UL-EU Certificate - UL-EU-01246-CPR >](#)

[ETA 22/0156 >](#)

[Certificate of constancy of performance - 2531-CPR-CXO10362 >](#)

[Fire Stopping Standard Details Guide >](#)

PRODUCT INFORMATION

Property	Description
Material	One-part neutral curing silicone
Weight	1.38g/cm ³ (nominal)
Colour	White
Shelf Life	12months*
Skin time	~ 10 minutes (23°C/50% r.h)
Flow resistance	2mm
Curing rate	3mm / 1 day (23°C/50% r.h)

*Shelf life is subject to product being stored appropriately. For unopened material, store in a well ventilated, dry, cool environment. Recommended temp ranges +5°C - +35°C. Protect against exposure to direct sunlight.

STANDARDS AND APPROVALS

Certificate
FirePro Silicone X has been tested to BS EN 1366-4:2006
CE marked to EAD 350141-00-1106
Third party certification through UL, Certificate No. UL-EU-01246-CPR





INSTALLATION

1. The substrate must be clean, dry, sound and homogeneous, free from oils, grease, dust and loose particles. The product does not require a primer on most common surfaces, although adhesion tests are recommended prior to full scale application.
2. Adequate space and accessibility should be provided for applying and tooling the sealant. A suitable backing material to control the sealant depth may be required, please refer to ETA 22/0156.
3. The joint depth should be such as to provide a minimum sealant depth required as per ETA 22/0156.
4. The sealant should be gunned firmly into the joint ensuring that it is in full contact with the sides of the joint. Failure to carry this out may result in poor adhesion of the sealant and ultimate failure of the joint.
5. Tooling of the sealant may be necessary to achieve an acceptable appearance. This is accomplished by drawing a flat tool over the surface of the sealant to produce a smooth neat finish. Tooling also compresses the sealant into the joint enhancing the adhesion to the joint sides.
6. Clean all tools and application equipment with water immediately after use.

Important:

- Not to be used where joints are to be constantly immersed in water.
- Do not use on substrates that are likely to release solvents, oils or plasticizers.

SPECIFICATION CLAUSES

ROCKWOOL Fire Resistant Silicone Sealant is associated with the following NBS clauses:

E40 Designed joints in in-situ concrete
530 Sealant
F30 Accessories/sundry items for brick/block stone walling
610 Movement joints with sealant
L10 Windows/Rooflights/Screens/Louvres
790 Fire resisting frames
L20 Doors/Shutters/Hatches
820 Sealant joints
P12 Fire stopping systems
395 Sealant: One part fire resisting acrylic




Cardridge system made from 100%
recycled plastics
Manufactured in UK
310 ml

FIREPRO[®]
Silicone X
Fire Resistant Sealant


ROCKWOOL



FirePro SP FireStop OSCB

Open-state cavity barrier for use exclusively with both RainScreen® Duo Slab and NyRock® RainScreen 032



Consisting of an intumescent strip fixed to high density non-combustible ROCKWOOL insulation, SP FireStop OSCB is designed to form an open-state cavity barrier within the building facade.

This allows the product to maintain ventilation and drainage of the cavity under normal service conditions, while in the event of a fire the intumescent strip will quickly expand outwards to seal off the cavity, preventing the passage of fire and smoke.

Exclusively designed and tested for use only in conjunction with ROCKWOOL RainScreen Duo Slab and NyRock RainScreen 032, SP FireStop OSCB forms an open-state cavity barrier within the building facade, which allows for ventilation and drainage of the cavity under service conditions.

The product comprises of a continuous intumescent strip fixed to the leading edge of a foil faced stone wool barrier, encapsulated by a weather-resistant polythene sleeve.

Tested to ASFP TGD 19, the combination of non-combustible insulation with effective intumescent, supports the construction of safe façade systems.

Installed horizontally and designed to ensure an appropriate open air space is maintained, the SP FireStop OSCB is suitable for cavity widths up to 600mm (see under 'Performance' for full details).

- Tested to "ASFP Technical Guidance Document 19: Fire resistance Test for 'open-state' cavity barriers used in the external envelope or fabric of buildings"
- Up to 120 minutes* fire integrity and insulation
- Satisfies NHBC and CWCT guidance for ventilation gaps at cavity barrier locations
- Wind and rain resistant
- Provides 25mm or 44mm airspace
- Easy site storage and handling
- Combined with either ROCKWOOL RainScreen Duo Slab or NyRock RainScreen 032 it simplifies the design of high rise buildings above 18m

*Subject to the application

APPLICATIONS

SP FireStop OSCB is suitable for use within ventilated façade systems.

PERFORMANCE

SP FireStop OSCB has been tested in accordance with ASFP TGD 19 and achieved the performances detailed in the table below. It is important to note that the fire resistance performance of the fire-stop is only as good as the performance of the supporting substrates in to which it is installed. Where fire-stopping is installed up to a non-fire resisting external wall then the performance of the fire-stop will be limited to the performance of the wall itself.

SP FireStop OSCB	Polythene wrap	Maximum dimensions (mm)		Fire performance (minutes)	
		Overall void	Open cavity	Integrity	Insulation
25	White; red text	600*	25	120	120
44	Red; white text	425	44	120	120

- SP FireStop OSCB 25 achieves up to 120 minutes, with a maximum open cavity of 25mm and maximum overall void of 600mm.
*For voids equal to 425mm and up to 600mm a minimum thickness of 300mm of Rainscreen Duo Slab /NyRock Rainscreen 032 is required both above and below the cavity barrier.
- SP FireStop OSCB 44 achieves up to 120 minutes, with a maximum open cavity of 44mm and maximum overall void of 425mm.

PRODUCT INFORMATION

Dimensions
Length: 1000mm
Thickness: 90mm

STANDARDS AND APPROVALS

Certificate
SP FireStop is tested to ASFP TGD 19.





Fire stopping: Section 3 - Linear joint seals

Total cavity size (mm)	RainScreen Duo Slab (mm)	SP FireStop OSCB 25		SP FireStop OSCB 44	
		Product width (mm)	Open cavity (mm)	Product width (mm)	Open cavity (mm)
100	50	75	25	56	44
110	60	85	25	66	44
120	70	95	25	76	44
125	75	100	25	81	44
130	80	105	25	86	44
140	90	115	25	96	44
150	100	125	25	106	44
160	110	135	25	116	44
170	120	145	25	126	44
175	125	150	25	131	44
180	130	155	25	136	44
190	140	165	25	146	44
200	150	175	25	156	44
210	160	185	25	166	44
220	170	195	25	176	44
230	180	205	25	186	44
240	190	215	25	196	44
250	200	225	25	206	44
260	210	235	25	216	44
270	220	245	25	226	44
275	225	250	25	231	44
280	230	255	25	236	44
290	240*	265	25	246	44
300	250*	275	25	256	44
310	260*	285	25	266	44
320	270*	295	25	276	44
330	280*	305	25	286	44
340	290*	315	25	296	44
350	300*	325	25	306	44
360	310*	335	25	316	44
370	320*	345	25	326	44
380	330*	355	25	336	44
390	340*	365	25	346	44
400	350*	375	25	356	44
410	360*	385	25	366	44
420	370*	395	25	376	44
425	375*	400	25	381	44

INSTALLATION

SP FireStop OSCB is only tested and certified for horizontal applications in conjunction with RainScreen Duo Slab or NyRock RainScreen 032.

For more detailed installation guidance, please download the SP FireStop OSCB Contractors' Guide from the ROCKWOOL website.

Note that the polythene wrap covering each section of barrier is not to be removed, and if cut must be reinstated.

SP FireStop OSCB is supplied ready to install with two galvanised steel fixing brackets and four pigtail screws per meter length.

The brackets should be mechanically and securely fixed to the wall at a maximum of 500mm centres using non-combustible fixings.

The product is impaled mid-barrier depth onto the fixing brackets, which should penetrate the barrier by at least half of the product width. The barrier must be pushed back sufficiently to ensure full contact with the supporting wall.

For SP FireStop OSCB 25 only, the front facing intumescent strip is secured to the barrier using the supplied pigtail screws, three per metre length at a maximum of 333mm centres. These screws should protrude from the front face of the barrier by a maximum of 25mm.

SP FireStop OSCB 44 should oversail the front face of the insulation, protruding into the cavity by at least 6mm.

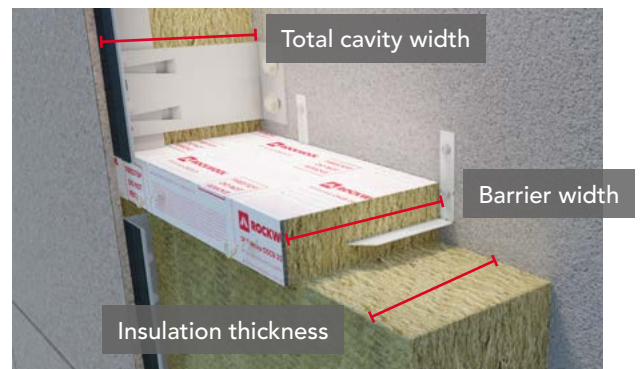
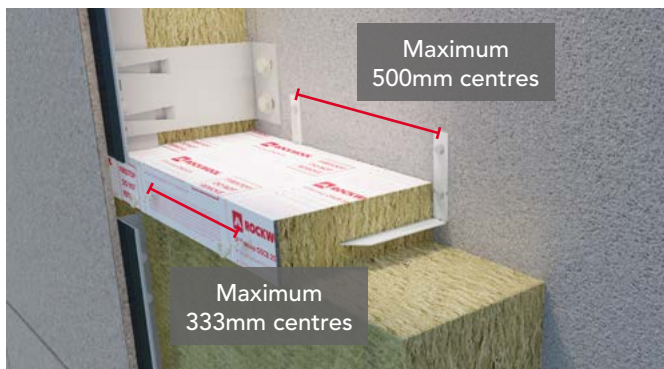
Adjacent lengths of barrier should be tightly butt jointed together.

At a corner detail where two runs of OSCB meet (for clarity; referred to as A and B): A should be continued out past the corner to tightly butt against the outer cladding, and B should tightly butt against A.

Where OSCB meets a vertical firestop, OSCB should be stopped and tightly butted against it.

For cut lengths, a minimum of two fixing brackets should be used.

Imperfections of up to 10mm can be filled with ROCKWOOL Acoustic Intumescent Sealant.



Ancillary products

SP FireStop OSCB Fixing Brackets

Required for installation, these galvanised steel brackets are supplied with SP FireStop OSCB at a rate of two per metre length. Brackets are packaged in a separate cardboard box located at the bottom of a pallet - the location will be marked with a label.

SP Fixing Brackets are designed to be easily re-profiled by hand on site, and should be cut as necessary to ensure they penetrate the barrier by at least 50% of its width.

Stainless steel brackets are available as an option.

Pigtail Screws

These are required for SP FireStop OSCB 25, and are used to secure the front-facing intumescent strip. They are supplied at a rate of 3 per metre length and will be packaged with the SP FireStop fixing brackets.

Care should be taken to ensure that the pigtail screws protrude from the front face of the firestop by a maximum of 25mm.



SP FireStop OSCB Fixing Brackets



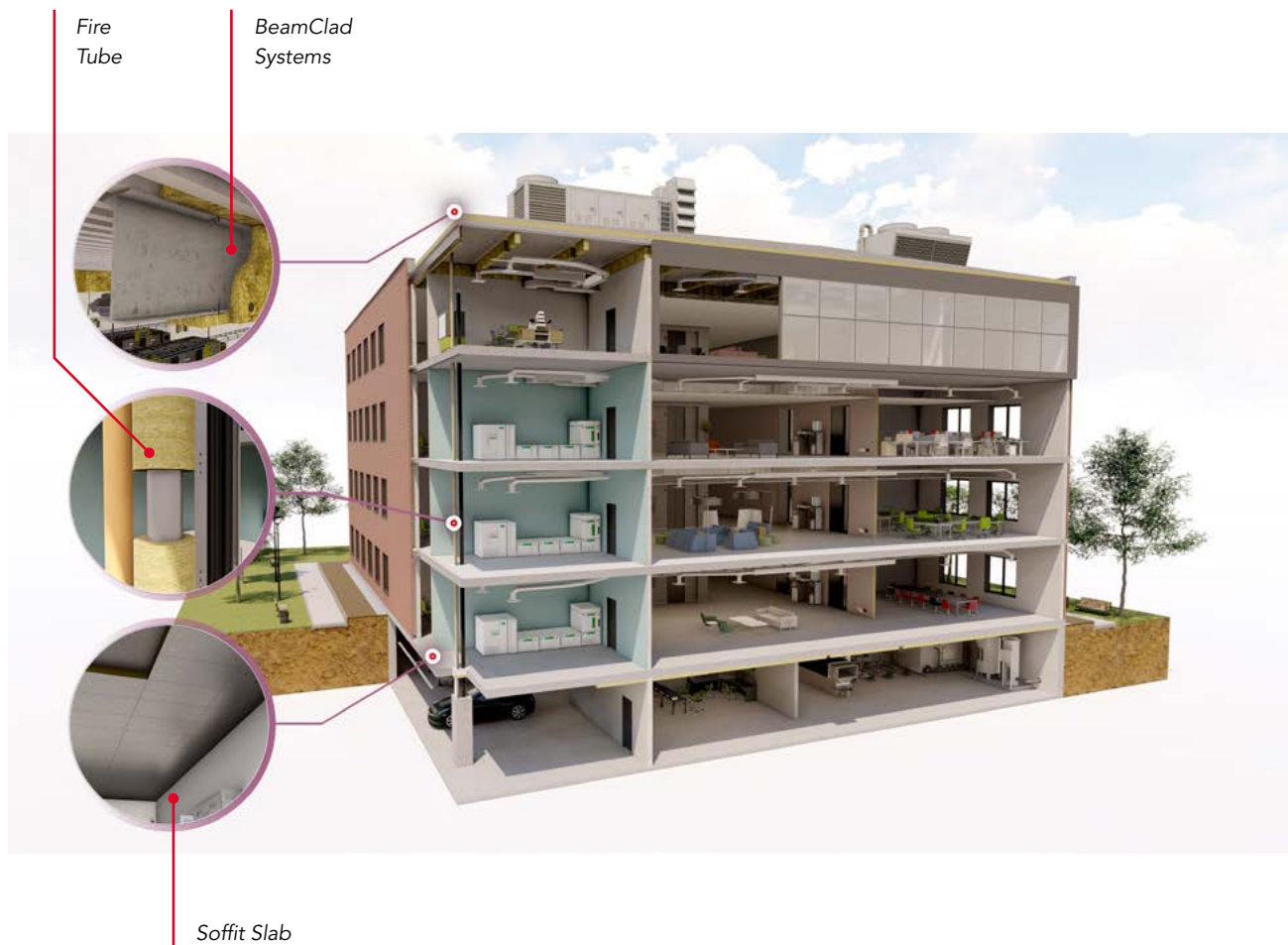
Pigtail Screws



Section 1: Structural steel/concrete

Many building materials can lose significant strength when exposed to high temperatures. Providing fire resistance to the load bearing structure of a building ensures that the building remains structurally stable in the event of a fire.

The ROCKWOOL range of fire protection products can withstand temperatures in excess of 1000°C providing protection to steel and concrete structures for periods of up to 4 hours. This vital protection ensure occupants can escape and firefighters can operate without the risk of collapse.



Core products



ROCKWOOL BeamClad Systems



ROCKWOOL Soffit Slab



ROCKWOOL Fire Tube

Useful documents and standards

ASFP Technical Guidance Document – TGD 14: Code of practice for the installation and inspection of board systems for the fire protection of structural steel

ASFP Yellow Book: Fire protection for structural steel in buildings

ASFP: Ensuring best practice for passive fire protection in buildings

BS 476-21: Fire test on building materials and structures. Method for determination of the fire resistance of load bearing elements of construction

BS EN 1365-2: Fire resistance test for load bearing elements. Floors & roofs

BS EN 1365-3: Fire resistance test for load bearing elements. Beams

BS EN 1365-4: Fire resistance test for load bearing elements. Columns

BS EN 1363-1: Fire resistance tests. General Requirements

BS EN 13501-2: Fire classification of construction products and building elements. Classification using test data from resistance to fire tests, excluding ventilation services.

ASFP (Association for Specialist Fire Protection) guidance documents can be sourced at www.asfp.org.uk



FirePro Soffit Slab

Thermal, fire and acoustic insulation for concrete soffits



ROCKWOOL Soffit Slab is manufactured using, non-combustible stone wool insulation. Available with a plain, foil or tissue facing which can provide up to 4 hours fire protection to the underside of concrete soffits.

Hi-Impact Soffit Slab

With a 6mm rigid fibre cement board facing, this combination of two non-combustible products provides increased impact resistance and durability. Available in various thicknesses, the off-white facing can be easily decorated to match design and colour schemes.

- Thermal performance
- Acoustic insulation
- Non-combustible stone wool insulation and facing options
- Up to 4 hours* fire resistance
- Water repellent
- Easily cut to accommodate services
- Simply butt together at joints
- Hi-impact option for durability

Soffit Slab consists of a non-combustible rigid ROCKWOOL board with a variety of facings.

Particularly suited for providing fire resistance and thermal insulation through concrete car park soffits and similar applications.

APPLICATIONS

Suitable for use with concrete soffits where a thermal, fire or acoustic performance is required.

PERFORMANCE

Fire performance

Soffit Slabs have been tested to BS EN 1363-1 to offer fire protection to reinforced concrete soffits. When applied to the soffit using the recommended fixings and pattern, 130 and 140mm thick products, with and without facings, provide 3 hours fire insulation and integrity to a minimum 90mm thick floor slab. 150 and 160mm thicknesses provide 4 hours to a minimum 150mm thick slab.

Thermal performance

ROCKWOOL Soffit Slab has a thermal conductivity (k value) of 0.034 W/mK.

Thermal resistance of un-faced Soffit Slab:

- 130mm Soffit Slab: 3.82 m²K/W
- 145mm Soffit Slab: 4.26 m²K/W
- 160mm Soffit Slab: 4.70 m²K/W

A typical construction comprising of a 150mm concrete floor slab underlined with 130mm thick Soffit Slab would achieve a U-value of 0.25W/m²K. A U-value of 0.20 W/m²K can be achieved using 160mm thick Soffit Slab.

PRODUCT INFORMATION

Property	Description
Length	1000mm (High Impact – 1200mm)
Width	600mm
Thickness	130, 145, 160mm
Thermal conductivity	0.034 W/mK
Reaction to fire	Euroclass A1
Fire resistance	Up to 4 hours

STANDARDS AND APPROVALS

Certificate
ROCKWOOL Soffit Slab achieves a reaction to fire classification of A1 as defined in BS EN 13501-1.



INSTALLATION

When fixing a tile or modular system, it is advisable to start with a focus reference slab in the centre of the soffit with subsequent slabs being fixed working towards each edge. The use of string lines or laser alignment equipment will assist in ensuring alignment and squareness of the installation.

Mechanical fixings

Soffit Slabs should be fixed direct to the concrete soffit using Ejot DDS fixings with the Ejot DDT70 washer or similar. Recommended number and pattern of fixings for each slab size are shown in figures 1 and 2 below. Care should be taken not to over-tighten fixings to prevent damage to slab surface. For further information on fixing type and suitability, please refer to the fixing manufacturer.

Fixing size guide

	High Impact Soffit Slab		Plain, Foil & Tissue Faced Soffit Slab		
Thickness	136mm	166mm	130mm	145mm	160mm
Ejot fixing	DDS 7.3 x 175mm	DDS 7.3 x 200mm	DDS 7.3 x 175mm	DDS 7.3 x 175mm	DDS 7.3 x 200mm
Ejot washer	DDT 70mm				

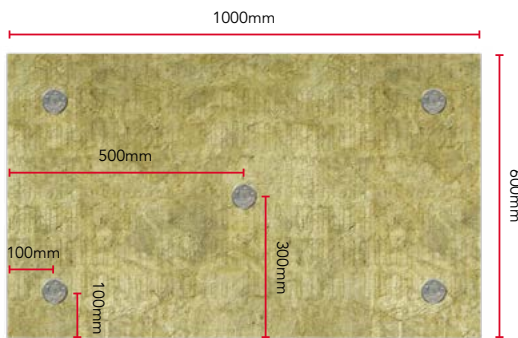


Figure 1

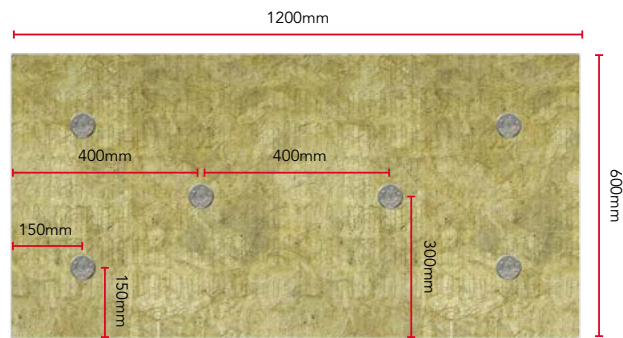


Figure 2

Light fittings and services

Soffit insulation products should not be used for supporting light fittings or services. Such installations should be supported from the concrete soffit.

SPECIFICATION CLAUSES

The insulation/fire protection of the concrete soffit is to be ROCKWOOL Soffit Slab alu-faced / High impact / white tissue / black tissue / un-faced¹mm thick², as manufactured by ROCKWOOL Limited, Pencoed, Bridgend CF35 6NY and installed in accordance with the manufacturer's recommendations.

¹Delete as necessary. ²Insert required thickness.

ROCKWOOL Soffit Slab is associated with the following NBS specification clauses:

K11 Rigid sheet flooring/sheathing/decking/sarking/linings/casings
885 Fire Protection Board
890 Board





FirePro Glue

Fire resistant adhesive for FirePro fire protection systems



ROCKWOOL FirePro Glue is a water based, fire resistant adhesive which is supplied in 17kg tubs and 300ml cartridges.

- LUL Approved
- Easy to apply
- Sets in as little as 4 hours
- Can be used from -10°C upward

Important note: The temperature of FirePro Glue must be 5°C or more when applied to surfaces at lower temperatures.

FirePro Glue has been specially formulated for use with FirePro BeamClad and ROCKWOOL Fire Duct Systems where glued joints or noggins are required.

FirePro Glue can also be used where there is a requirement for a fire resistant adhesive. The product has been widely used in fire tests conducted on ROCKWOOL Fire Protection Systems - achieving fire ratings of up to four hours.

APPLICATIONS

FirePro Glue is suitable for use with FirePro BeamClad and ROCKWOOL Fire Duct Systems where glued joints or noggins are required. FirePro Glue can also be used in conjunction with other ROCKWOOL Stone Wool products where there is a requirement for a fire resistant adhesive.

Frost exposure does not remove curing ability.

The use of FirePro Glue is not limited to particular temperatures and has been tested when applied to surfaces with temperatures of -10°C and upwards, but the curing rate in-situ can be affected by:

- Temperature (see Table 1)
- Air humidity
- Thickness of glue layer in a joint
- Air access to glued joint (i.e. not sealed off)

PERFORMANCE

FirePro Glue has been widely used in fire tests conducted on ROCKWOOL FirePro Fire Protection Systems where fire ratings of up to 4 hours* have been achieved. For further information tested applications please contact ROCKWOOL.

*Subject to the application

PRODUCT INFORMATION

Property	Tub	Cartridge
Pack Size	17kg Tub	300ml cartridge
Application temperature	Surface temperature of $\geq -10^{\circ}\text{C}$ (Glue must be $\geq 5^{\circ}\text{C}$)	Surface temperature of $\geq -10^{\circ}\text{C}$ (Glue must be $\geq 5^{\circ}\text{C}$)
pH	11	11
Shelf Life	12 months	18 months
Fire Rating	Up to 4 hours (When tested with ROCKWOOL Fire Protection Systems)	Up to 4 hours (When tested with ROCKWOOL Fire Protection Systems)

STANDARDS AND APPROVALS

Certificate

This product has been authorised for use in LUL surface and sub-surface premises when installed in accordance with this datasheet - please refer to the LUL Approved Product Register website www.LU-apr.co.uk for specific details.

INSTALLATION

Application of glue from tub is typically made by a pallet knife or trowel before pressing surfaces together. The product must always be stirred before use to ensure a uniform product consistency. Application of glue from cartridge is made using a sealant gun and spread evenly over the surface with a spatula or similarly flat bladed tool. Fixing boards together is supplemented by nails, pins or staples through noggin board joints and board joints.

Whilst steel surfaces may be acceptable when just moist to the touch, heavy water droplets, grease, scale oxide, dust etc should be removed prior to the application of FirePro Glue.

Testing has shown that even if glued joints are immediately subjected to heavy frost exposure, the final glued joint strength is not threatened, but curing is retarded.

Glue fixed noggins must be allowed to set fully before any attempt is made to fix cover boards. Table 1 suggests minimum times to allow such setting to occur between ROCKWOOL BeamClad noggins and steelwork.

FirePro Glue may be used to attach cover boards onto cured noggins (and in glued board joints), provided that a 24 hour interval is acceptable before further trades work on such protected steelwork.

Important note: when friction fitted glued joints are exposed to sub-zero temperatures either immediately, or at some time during the curing process, adequate bond stability will form in approximately 1 hour. This bond will be sufficient for cover boards to be applied. Full setting will continue as in Table 1 when frost free conditions return, but stability will be provided by the supplementary pins or nails. The final strength of the glued joints will not be affected by exposure to sub-zero temperatures during the curing process.



Noggins to steelwork

Exhaustive testing has been made under various application conditions. All noggins fitted into steelwork should be cut to provide an interference friction fit of approximately 0.5mm. Excessive oversizing causing the noggins to bend should be avoided (refer to Figures 1-3).

The noggins should be installed so as to be just proud of the flange tips. For web depths greater than 500mm 'solid' noggins or 'T' noggins ROCKWOOL BeamClad must be used.

Again a nominal 0.5mm interference fit is recommended for all ambient conditions, but particularly for winter working. All noggin edges in contact with steelwork must be glued.

Figure 1

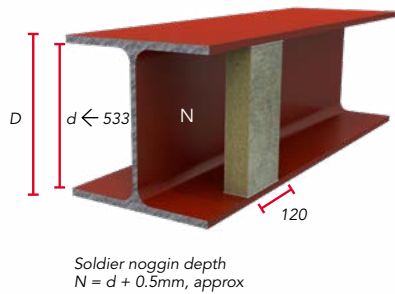


Figure 1a

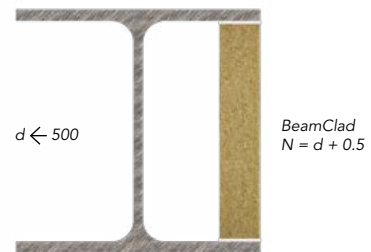


Figure 2

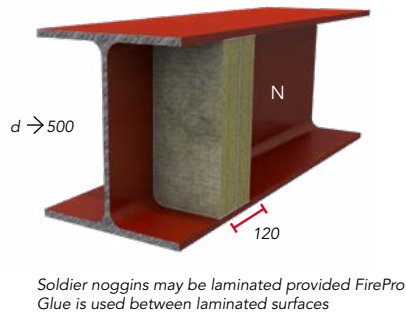


Figure 2a



Figure 3

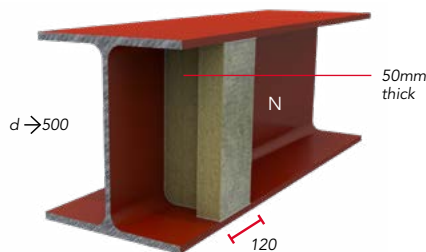
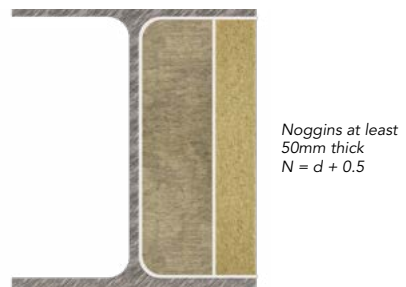


Figure 3a



Ambient conditions & curing times

For all year round working, noggins should be cut to provide approximately 0.5mm interference fit into steelwork. Some friction in the fitting is required to satisfy all conditions and to provide a sensible limit to glue thickness.

In typical dry summer conditions of 20°C, curing of the basic glue will occur in approximately 4 hours before cover boards should be added onto the noggins.

The setting times of glue in moist air conditions is approximately 6-8 hours if the temperature is above freezing point, or in approximately 1 hour at 20°C.

Table 1

Setting times for different conditions

Conditions	Setting time
Approx 20°C dry conditions	Approx 4 hours
Approx 3°C+ with moist air conditions	Greater than 24 hours expected
-10°C to 0°C	Adequate bond forms within 1 hour but full cure may be delayed over 24 hours when temperatures 0 - 6°C

Storage

Generally storage should be made in frost free conditions. Should frost exposure occur, the glue should be thawed out and thoroughly stirred.





FirePro BeamClad Systems

Fire protection solutions for structural steel & soffit protection

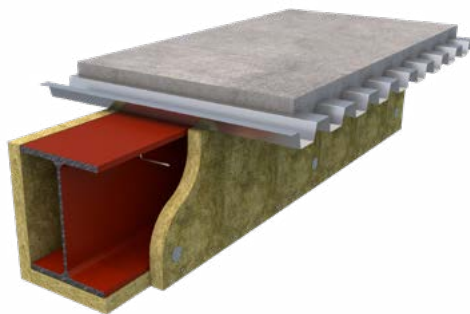


ROCKWOOL BeamClad is manufactured using, non-combustible stone wool insulation. Available in a plain, foil or tissue faced finish, BeamClad can provide up to 4 hours* fire protection to structural steel.

ROCKWOOL BeamClad boards are sized 2000 x 1200mm, in a range of thicknesses from 25mm up to 50mm (as standard).

- Up to 4 hours* fire resistance
- **Fire rated timber floor applications
- Moisture repellent
- Quick and simple to apply
- No maintenance

Figure 1
FirePro
BeamClad
Systems



*Subject to the application

**For further information on fire rated timber floor applications please contact ROCKWOOL Technical Support.

ROCKWOOL BeamClad systems provide a 'tool-box' of options and have been assessed based on fire test data carried out to ENV 13381-4:2002 and EN 13381-4:2013 and in accordance with ASFP Yellow Book, Fire Protection for Structural Steel in Buildings, 5th Edition.

They offer contractors simple and economical fire protection solutions to the very real diversity of modern steel constructions.

APPLICATIONS

FirePro BeamClad Systems have been specially designed to provide fire protection to structural steel for periods of up to 4 hours*. BeamClad Systems provide a flexible range of fixing solutions for all applications, these include:

- Complete glued system
- Welded pins/glued joint system
- Welded pins/dry joint system

FirePro BeamClad can also be used to provide fire protection to timber floor systems for periods of up to 90mins* with a complete dry fixed system.

High air flow applications

Un-faced ROCKWOOL BeamClad Systems have been evaluated for use in return air plenums, by the Institute of Occupational Medicine to World Health Organisation test standards and for use in subways, for train speeds up to 150 km per hour.

PERFORMANCE

Fire performance

BeamClad Systems provide up to 4 hours* fire resistance for structural steelwork, assessed at critical temperatures between 350°C and 800°C, including the default temperatures of 550°C (columns) and 620°C (beams). Un-faced, aluminium-foil and glass tissue faced product options comply with non-combustible definitions as referenced in UK Building Regulations. *Subject to the application

Table 1 Fire performance of BeamClad Systems

System	Fire resistance (mins)					
	30	60	90	120	180	240
Glued noggins, glued application, glued board joints	✓	✓	✓	✓	✓	✓
Welded pins, glued board joints	✓	✓	✓	✓	✓	✓
Welded pin, dry board joints	✓	✓	✓	✓	✓	

STANDARDS AND APPROVALS

Certificate
ROCKWOOL BeamClad fire protection materials have been assessed to ENV 13381-4:2002 & EN 13881-4:2013 for the fire protection of loadbearing steelwork for up to 4 hours protection.
ROCKWOOL BeamClad achieves a reaction to fire classification of A1 as defined in BS EN 13501:1.
This product has been authorised for use in LUL surface and sub-surface premises when installed in accordance with this datasheet - please refer to the LUL Approved Product Register website www.LU-apr.co.uk for specific details.

PRODUCT INFORMATION

Property	Description
Length	2000mm
Width	1200mm
Thickness	25 – 100mm*
Density	167 – 180kg/m ³
Reaction to Fire	Euroclass A1
Fire Resistance	Up to 4 hours**

* Single board thickness

**Subject to the application



INSTALLATION

FirePro BeamClad Systems provide a flexible range of fixing options to meet a variety of site requirements. BeamClad Systems can be broken down into two main types:

1) ROCKWOOL BeamClad dry joint systems

These use stud welded pins to secure the insulation to all structural steel sections. All board-to-board joints are straight butt joints, without the need for glue.

2) ROCKWOOL BeamClad glued joint systems

These use an inorganic and non-toxic glue to bind board-to-board joints and/or to the noggins. Galvanised nails of at least 2.5mm for nails shorter than 100mm and at least 4mm for 100mm nails or longer. Nails twice the thickness of insulation, are used to hold the joints together whilst the glue cures. Alternatively, pigtail screws can be used instead of galvanised nails. Pigtail screws should be minimum 2 x thickness of cover board -5mm.

Installation option 1: Dry board joint systems

Stud welded pin application

A dry joint system employing steel welded pins. The system is installed using 2.7mm diameter stud-welded pins.

The steelwork is cleaned in the area where the welded pin is to be positioned. The pin is then welded to the steel flange.

The ROCKWOOL BeamClad board is then impaled on to the stud welded pins and held in place with 28mm diameter spring steel non-return washers.

The stud welded pins are fixed at max. 320mm centres to top flange and to bottom flange.



Figure 2

Stud welded pin dry joint board system
(Up to 3 hours fire protection)



Figure 3

Two-sided protection with stud welded pins
(Up to 3 hours fire protection)

Installation option 2: Glue joint system

Glue-fixed noggins and board-to-board glued joints

ROCKWOOL BeamClad noggins (at 1000mm nominal centres) are glued between the steelwork flanges, and the ROCKWOOL BeamClad side boards are glued to the noggins, ensuring transverse board joints are coincident with the noggins. The ROCKWOOL BeamClad side boards are also glued at all vertical joints and horizontal board-to-board joints.

Round head nails (length $\geq 2 \times$ thickness of board) are fixed through the side boards into the noggins (min 2) and soffit boards (at 400mm nominal centres) to consolidate the glued joints.

Stud welded pins and board-to-board glued joints

Pins are stud welded at max. 320mm centres to top flange and to bottom flange. All board-to-board joints are glued and nailed.



Figure 4

Glue-fixed noggins and board-to-board glued joints
(Up to 4 hours fire protection)



Figure 5

Stud welded pins and board-to-board glued joints
(Up to 4 hours fire protection)

FirePro Glue – Coverage rates for glued joint systems

FirePro Glue is an inorganic, non-toxic product with a pH of 11. FirePro Glue is supplied pre-mixed in 17kg tubs. A variety of joint types can be used (see previous page).

Coverage rate will depend on the linear length of the joints, width of joint (board thickness) and joint depth. Assuming total, effective usage of the glue on site, the following table provides an approximate weight (kg) of glue per linear metre of joint, based on a glue depth of 1mm.

ROCKWOOL BeamClad thickness (mm)	Square butt joint
25	0.09
30	0.11
35	0.13
40	0.15
50	0.19
60	0.22

Important:

Care should be taken when using FirePro Glue with foil faced BeamClad as the alkalinity of the glue is very high and can react with the foil. Avoid any contact between the glue and the foil layer, if contact occurs remove the glue immediately with a damp cloth.

In practice, a degree of wastage would be expected and as such, it would be prudent to make an allowance for this when placing an order. As a very approximate guide, the coverage rate of a 17kg tub of FirePro Glue would be 35m² of applied board.



Board jointing options

Butted corner joints: Butted corner joints are made with square edge boards using either a dry joint, or FirePro Glue and nails/pigtail screws at 400mm centres.

Axial joints: All axial joints are made with square butt edges, without nails. Glue is only required for glued board systems. For Foil faced products, joints can be finished with Class 'O' foil tape.

Noggins: ROCKWOOL BeamClad boards can be fixed to noggins, cut from ROCKWOOL BeamClad offcuts of at least the same thickness as the facia and soffit boards.

The edges of the noggins are glued where they contact the steelwork, then, once the glue has set firmly, the cover boards are fixed in position with FirePro Glue and nails/pigtail screws.

Welded steel pins: Boards are impaled onto stud welded pins and secured with non-return washers.

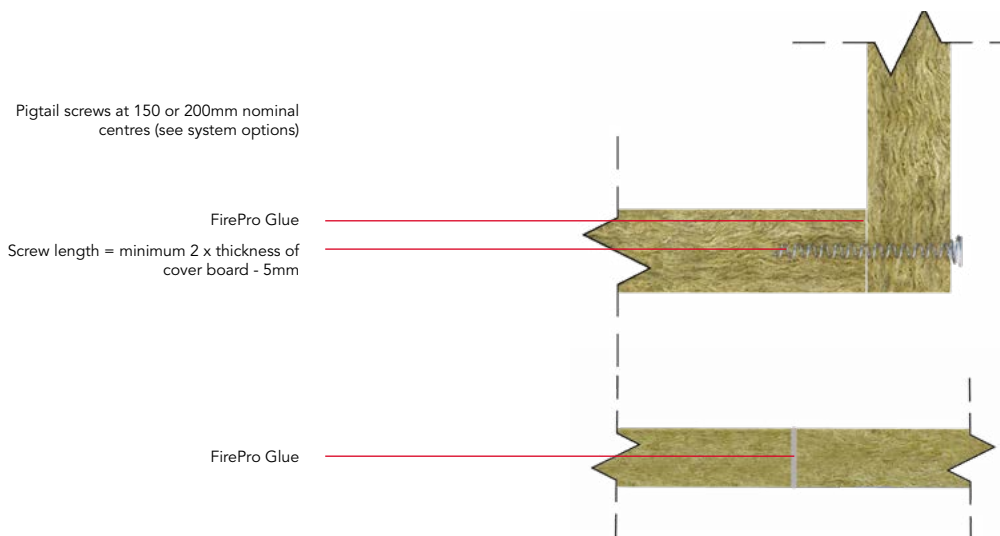


Figure 6

Cellular beams

Thickness calculation method

The method for determining the thickness of ROCKWOOL BeamClad required to protect a cellular or castellated beam shall be determined as the highest value derived from the following:

- The section factor of the I section above the opening
- The section factor of the I section below the opening
- Calculate the effective section factor using the following equation:
Section factor $(m-1) = 1400 / t$, where t = the thickness (mm) of the lower steel web
- Confirm the limiting design temperature of the beam with the manufacturer. In the absence of such information, a conservative fail temperature of 450°C can be used.
- Using the calculated section factor and protection period required, determine the thickness of ROCKWOOL BeamClad for a solid beam from the appropriate fire protection table for the limiting design temperature (or 450°C) and the fixing system being considered.
- Multiply this thickness by 1.20 to obtain the ROCKWOOL BeamClad thickness for the cellular or castellated beam.

Installation options – cellular beams

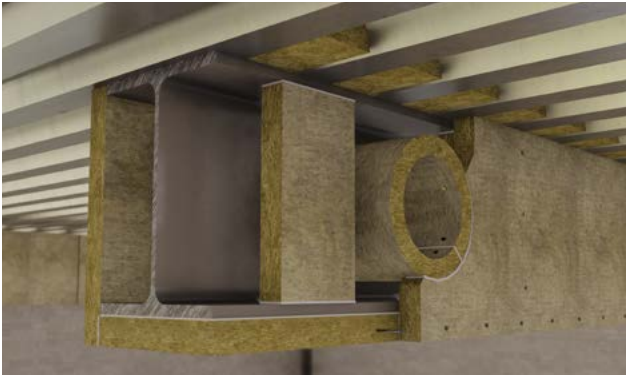


Figure 7
Beam with circular holes
(boxed protection - glued and pinned joints)



Figure 8
Beam with square or rectangular holes
(boxed protection - glued and pinned joints)



Figure 9
Beam with circular holes
(boxed protection - dry joints)



Figure 10
Beam with square or rectangular holes
(boxed protection - dry joints)

FirePro BeamClad System Ancillaries

- Pigtail screws are available from ROCKWOOL stockists.
- Welded pins and sprung steel non-return washers are available from external suppliers.
- Fire Duct / DuctRock ductwork solutions are also available for steel duct protection.

SPECIFICATION CLAUSES

(To be read in conjunction with System Options on previous pages)

1. The structural steel is to be fire protected using ROCKWOOL BeamClads system, with a.....f facing, to provide.....h fire resistance.
2. The main fixing system will be one of:
 - ROCKWOOL BeamClad noggin system and glued joints fixed at 1000mm centres.
 - ROCKWOOL BeamClad stud welded pin system fixed at max. 320mm centres to top flange, and to bottom flange.
3. Board-to-board joints can be dry fixed or glued and nailed/pigtail screwed in accordance with the data sheet.
^s insert system type / ^f insert facing option / ^h insert period of fire resistance

FirePro BeamClad Systems are associated with the following NBS specification clauses

K11 Rigid sheet flooring/sheathing/decking/sarking/linings/casings

885 Fire protection board

890 Board



FirePro Fire Tube

Fire protection for structural steel



FirePro Fire Tube is a pre-formed cylindrical insulation manufactured using ROCKWOOL stone wool. The product is available with an optional aluminium foil facing.

Fire Tube is suitable for structural steel circular columns up to 438mm in diameter, and is supplied in metre lengths.

For standard wall thicknesses and size availability, please see the current ROCKWOOL price list.

Rigid pre-formed cylindrical sections of stone wool insulation

Fire Tube has been specifically engineered and tested to fire protect structural steel circular hollow columns.

APPLICATIONS

Fire Tube has been tested to fire protect structural steel circular hollow columns.

It may be possible to use this test data in assessing the performance of Fire Tube when applied to other circular elements, such as pipework - however such assessments should be undertaken by a suitably qualified individual.

Please contact the ROCKWOOL Fire Team for further information.

PERFORMANCE

Fire performance

Fire Tube has been designed to fire protect structural steel circular hollow columns in the range of 350°C to 750°C for fire resistance periods of up to 3 hours.

The required wall thickness of Fire Tube to provide a particular fire resistance for a specified period depends on the diameter, wall thickness and design temperature of the steel column.

Structural steel fire protection

The following table gives the thickness of Fire Tube required to protect standard circular hollow sections for up to 3 hours.

For sections not covered, or alternative design temperatures, please contact ROCKWOOL Technical for assistance in calculating the required thickness of Fire Tube.

Circular hollow section					Required thickness (mm) for a given protection period											
O.D. (mm)	Wall thickness (mm)	Mass (kg/m)	Section Area (cm ²)	A/V (m ⁻¹)	Design temperature 400°C						Design temperature 550°C					
					30 min	60 min	90 min	120 min	150 min	180 min	30 min	60 min	90 min	120 min	150 min	180 min
33.7	3.6	2.67	3.4	310	25	60	90	-	-	-	25	40	70	95	-	-
	4	2.93	3.73	285	25	60	90	-	-	-	25	40	70	95	-	-
42.4	3.6	3.44	4.39	305	25	60	90	-	-	-	25	40	70	95	-	-
	4	3.79	4.83	275	25	55	90	-	-	-	25	40	65	95	-	-
	5	4.61	5.87	230	25	55	85	-	-	-	25	35	65	90	-	-
48.3	3.6	3.97	5.06	300	25	60	90	-	-	-	25	40	70	95	-	-
	4	4.37	5.57	270	25	55	90	-	-	-	25	40	65	95	-	-
	5	5.34	6.8	225	25	55	85	-	-	-	25	35	65	90	-	-
60.3	3.6	5.03	6.41	295	25	60	90	-	-	-	25	40	70	95	-	-
	4	5.55	7.07	270	25	55	90	-	-	-	25	40	65	95	-	-
	5	6.82	8.69	220	25	50	85	-	-	-	25	35	60	90	-	-
76.1	3.6	6.44	8.2	290	25	60	90	-	-	-	25	40	70	95	-	-
	4	7.11	9.06	265	25	55	85	-	-	-	25	40	65	95	-	-
	5	8.77	11.2	215	25	50	80	-	-	-	25	35	60	90	-	-
	6.3	10.8	13.8	175	25	45	75	105	-	-	25	30	55	80	-	-
88.9	3.6	7.57	9.65	290	25	60	90	-	-	-	25	40	70	95	-	-
	4	8.38	10.7	260	25	55	85	-	-	-	25	40	65	95	-	-
	5	10.3	13.2	210	25	50	80	-	-	-	25	35	60	85	-	-
	6.3	12.8	16.3	170	25	45	75	105	-	-	25	30	55	80	-	-
114.3	3.6	9.83	12.5	285	25	60	90	-	-	-	25	40	70	95	-	-
	4	10.9	13.9	260	25	55	85	-	-	-	25	40	65	95	-	-
	5	13.5	17.2	210	25	50	80	-	-	-	25	35	60	85	-	-
	6.3	16.8	21.4	170	25	45	75	105	-	-	25	30	55	80	-	-
139.7	3.6	12.1	15.4	285	25	60	90	-	-	-	25	40	70	95	-	-
	4	13.4	17.1	255	25	55	85	-	-	-	25	40	65	90	-	-
	5	16.6	21.2	205	25	50	80	-	-	-	25	35	60	85	-	-
	6.3	20.7	26.4	165	25	45	75	105	-	-	25	30	55	80	105	-
	8	26	33.1	135	25	40	65	95	-	-	25	25	45	75	100	-
168.3	10	32	40.7	110	25	30	60	85	-	-	25	25	40	65	90	-
	5	20.1	25.7	205	25	50	80	-	-	-	25	35	60	85	-	-
	6.3	25.2	32.1	165	25	45	75	105	-	-	25	30	55	80	105	-
	8	31.6	40.3	130	25	35	65	95	-	-	25	25	45	70	100	-
	10	39	49.7	105	25	30	55	85	-	-	25	25	35	60	90	-
193.7	12.5	48	61.2	85	25	25	45	70	95	-	25	25	25	50	75	100
	5	23.3	29.6	205	25	50	80	-	-	-	25	35	60	85	-	-
	6.3	29.1	37.1	165	25	45	75	105	-	-	25	30	55	80	105	-
	8	36.6	46.7	130	25	35	65	95	-	-	25	25	45	70	100	-
	10	45.3	57.7	105	25	30	55	85	-	-	25	25	35	60	90	-
219.1	12.5	55.9	71.2	85	25	25	45	70	95	-	25	25	25	50	75	100
	5	26.4	33.6	205	25	50	80	-	-	-	25	35	60	85	-	-
	6.3	33.1	42.1	165	25	45	75	105	-	-	25	30	55	80	105	-
	8	41.6	53.1	130	25	35	65	95	-	-	25	25	45	70	100	-
	10	51.6	65.7	105	25	30	55	85	-	-	25	25	35	60	90	-
	12.5	63.7	81.1	85	25	25	45	70	95	-	25	25	25	50	75	100
219.1	14.2	71.8	91.4	75	25	25	40	65	90	-	25	25	25	45	70	95
	16	80.1	102	65	25	25	35	55	80	100	25	25	25	35	60	85

Table continues on next page



Fire protection: Section 1 - Structural steel/concrete

Circular hollow section					Required thickness (mm) for a given protection period											
					Design temperature 400°C						Design temperature 550°C					
					30 min	60 min	90 min	120 min	150 min	180 min	30 min	60 min	90 min	120 min	150 min	180 min
O.D. (mm)	Wall thickness (mm)	Mass (kg/m)	Section Area (cm ²)	A/V (m ⁻¹)												
244.5	5	29.5	37.6	205	25	50	80	-	-	-	25	35	60	85	-	-
	6.3	37	47.1	165	25	45	75	105	-	-	25	30	55	80	105	-
	8	46.7	59.4	130	25	35	65	95	-	-	25	25	45	70	100	-
	10	57.8	73.7	105	25	30	55	85	-	-	25	25	35	60	90	-
	12.5	71.5	91.1	85	25	25	45	70	95	-	25	25	25	50	75	100
	14.2	80.6	103	75	25	25	40	65	90	-	25	25	25	45	70	95
16	90.2	115	65	25	25	35	55	80	100	25	25	25	35	60	85	
273	5	33	42.1	205	25	50	80	-	-	-	25	35	60	85	-	-
	6.3	41.4	52.8	160	25	45	75	100	-	-	25	25	55	80	105	-
	8	52.3	66.6	130	25	35	65	95	-	-	25	25	45	70	100	-
	10	64.9	82.6	105	25	30	55	85	-	-	25	25	35	60	90	-
	12.5	80.3	102	85	25	25	45	70	95	-	25	25	25	50	75	100
	14.2	90.6	115	75	25	25	40	65	90	-	25	25	25	45	70	95
16	101	129	65	25	25	35	55	80	100	25	25	25	35	60	85	
323.9	5	39.3	50.1	205	25	50	80	-	-	-	25	35	60	85	-	-
	6.3	49.3	62.9	160	25	45	75	100	-	-	25	25	55	80	105	-
	8	62.3	79.4	130	25	35	65	95	-	-	25	25	45	70	100	-
	10	77.4	98.6	105	25	30	55	85	-	-	25	25	35	60	90	-
	12.5	96	122	85	25	25	45	70	95	-	25	25	25	50	75	100
	14.2	108	138	75	25	25	40	65	90	-	25	25	25	45	70	95
16	121	155	65	25	25	35	55	80	100	25	25	25	35	60	85	
355.6	6.3	54.3	69.1	160	25	45	75	100	-	-	25	25	55	80	105	-
	8	68.6	87.4	130	25	35	65	95	-	-	25	25	45	70	100	-
	10	85.2	109	100	25	30	55	80	105	-	25	25	35	60	85	-
	12.5	106	135	85	25	25	45	70	95	-	25	25	25	50	75	100
	14.2	120	152	75	25	25	40	65	90	-	25	25	25	45	70	95
	16	134	171	65	25	25	35	55	80	100	25	25	25	35	60	85
406.4	6.3	62.2	79.2	160	25	45	75	100	-	-	25	25	55	80	105	-
	8	78.6	100	130	25	35	65	95	-	-	25	25	45	70	100	-
	10	97.8	125	100	25	30	55	80	105	-	25	25	35	60	85	-
	12.5	121	155	80	25	25	45	70	95	-	25	25	25	50	75	95
	14.2	137	175	75	25	25	40	65	90	-	25	25	25	45	70	95
	16	154	196	65	25	25	35	55	80	100	25	25	25	35	60	85

PRODUCT INFORMATION

Property	Description
Length	1000mm
Internal diameter range	Up to 438mm
Thickness range	25 – 100mm
Fire resistance	Up to 3 hours

STANDARDS AND APPROVALS

Fire Tube has been authorised for use in LUL surface and sub-surface premises when installed in accordance with this datasheet - please refer to the LUL Approved Product Register website www.LU-apr.co.uk for specific details.

INSTALLATION

FirePro Fire Tube is light and easy to cut to shape using a saw or a sharp knife.

All joints should be held firmly together with temporary bands of steel wire, jubilee clips or plastic cable ties at 200mm centres until the glue has fully cured.

If installed outdoors, Fire Tube must be protected from the weather. Prior to use, Fire Tube should be stored indoors or protected by a weatherproof covering





ROCKWOOL BeamClad Systems Contractor Fixing Guide

ROCKWOOL BeamClad Systems provide a 'tool-box' of options and have been assessed based on fire test data carried out to ENV 13381-4:2002 and EN 13381-4:2013 and in accordance with ASFP Yellow Book, Fire Protection for Structural Steel in Buildings, 5th Edition.

They offer contractors simple and economical fire protection solutions to the very real diversity of modern steel constructions.

This section explains and illustrates the installation methods using the following fixing options:

- Stud welded pin dry joint board system
- Stud welded pin glued jointed board system
- Glue fix noggin, glued jointed board system
- Tested and approved for solid and cellular sections







Description

BeamClad boards are available with facings of glass tissue and reinforced aluminium foil as well as plain product. Size: 2000 x 1200mm. Standard thicknesses: 25, 30, 35, 40 and 50mm. Single board thicknesses up to 100mm are available.

Scope

Contractors are required to install materials as tested and detailed in this brochure. In situations not covered by this brochure, ROCKWOOL will either recommend a suitable detail or assist in obtaining an independent Design Appraisal.

Applications

This Fixing Guide provides details of all of the standard boxed applications. It covers fixing centres and details of available facings and joint details. Dry board joints for up to 3 hours and glued joints up to 4 hours protection.

Stud welded pin, dry joint board systems

Welded pin fixing solutions with dry joints are extremely quick to apply, reduce system installation costs and eliminate the need for glue.

Glued noggin fix and stud welded pin systems – glued joints

The glued joint ROCKWOOL BeamClad systems remain for the applications that require fire protection periods of up to 4 hours.

Advantages

- Fast to install, dry fix stud welded pin system
- Only dry joint stud welded pin solution
- Stud pin fixing centres at max. 320mm for top flange and bottom flange
- Up to 3 hours fire protection

ROCKWOOL BeamClad stud welded pin dry joint board system

A traditional stud welded pin solution with dry joints. This dry fix pin solution can be used for 2, 3 and 4-sided beam protection for a period of up to 3 hours.

Installation sequence

1. Clean the local area for pin welding and fix stud pin using arc or CD welds, ensuring a good contact has been achieved. Stud-welded pins are a minimum 2.7mm diameter. Test weld by bending pin.
2. Impale the ROCKWOOL BeamClad boards onto the stud welded pins using the deck soffit as a guide.
3. Push 28mm diameter sprung steel non-return washers onto the exposed pin until tight to the cover board face. Crop pins as necessary.
4. Tape joints using aluminium foil tape or scrim, if required.
5. In the case of beams, the pins are welded to the steel section along the flange tips and in two rows along the face of the bottom flange, nominally 50mm in from each edge.
6. Transverse joints in the boards fixed to the webs are offset with respect to those fixed to the flange by a minimum of 100mm.



Figure 1
Stud welded pin, dry joint board system



Chart 1 - ROCKWOOL BeamClad stud welded pin dry joint system:
Critical steel temperature 620°C, 3 sided protection for beams

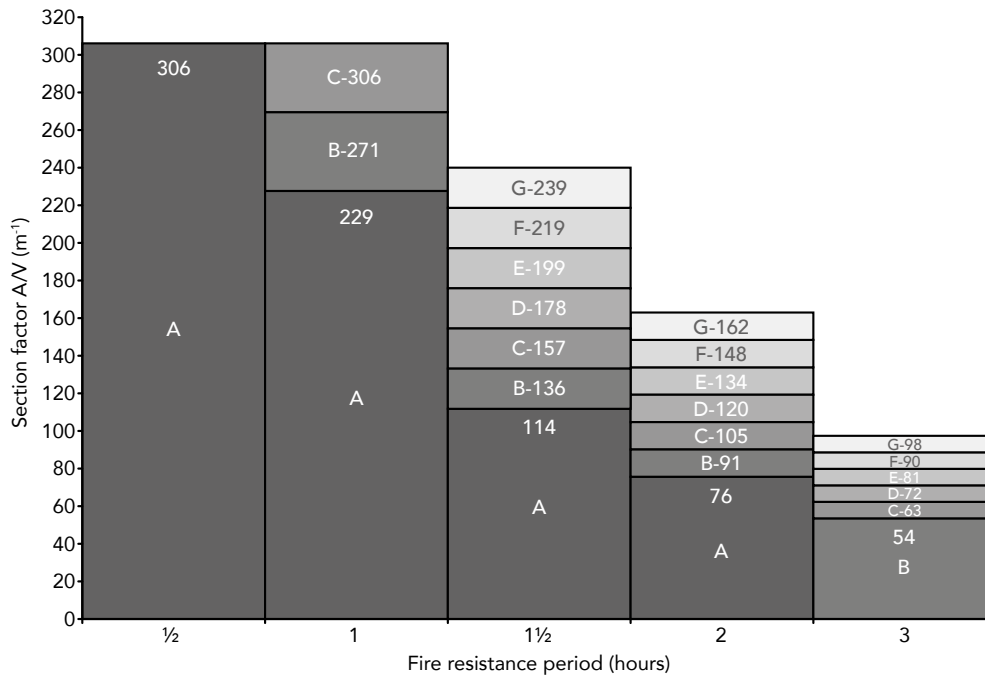
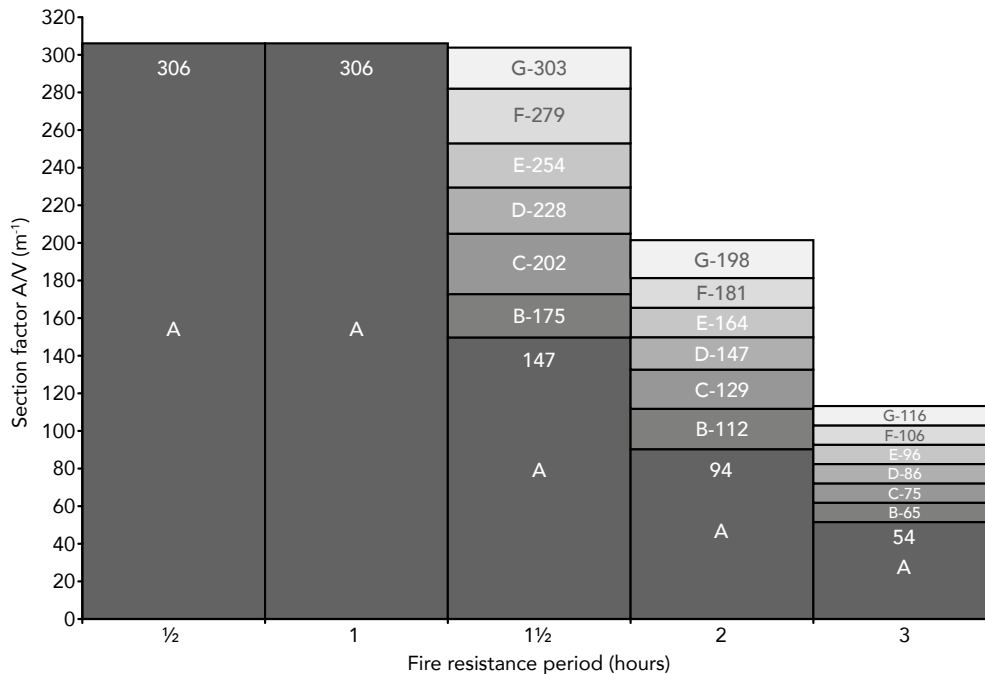


Chart 2 - ROCKWOOL BeamClad stud welded pin dry joint system:
Critical steel temperature 550°C, 4 sided protection for beams and columns



The following key provides the required minimum thicknesses of ROCKWOOL BeamClad for the Section Factors given in the tables above.

A = 25mm B = 30mm C = 35mm D = 40mm E = 45mm F = 50mm G = 55mm

Typical details



FirePro Trapezoidal FireStop

Pins at max 320mm c/c to bottom flange see D below

Figure 2
3-sided box

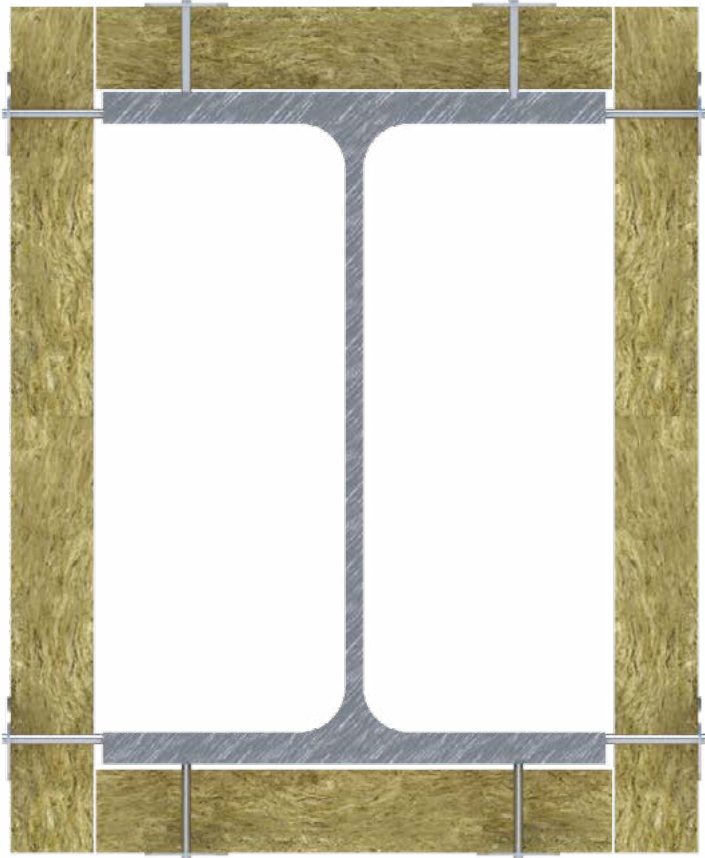


Figure 3
4-sided box



Fixing patterns

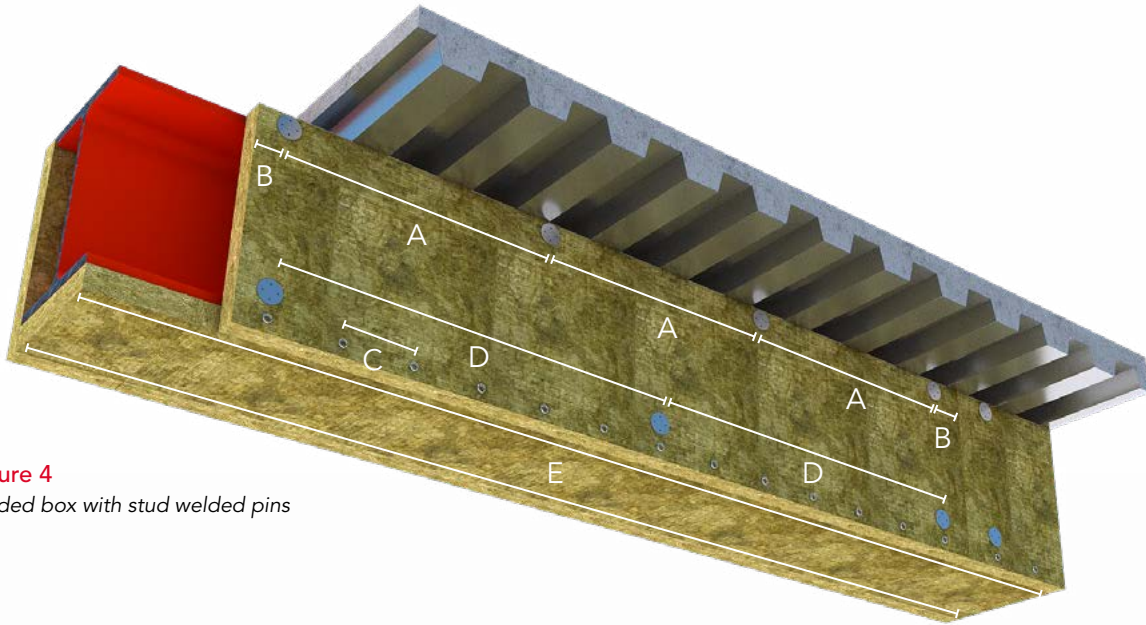


Figure 4
3-sided box with stud welded pins

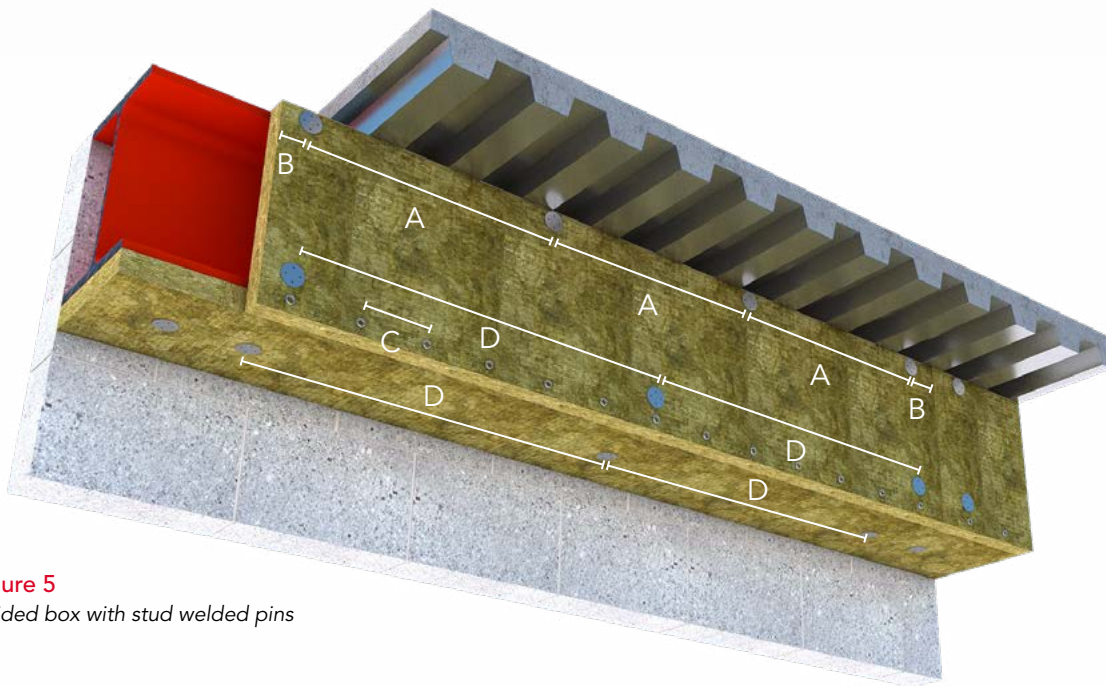


Figure 5
2-sided box with stud welded pins

Dimensions

A = Stud welded pins at max. 320mm centres

B = Stud welded pins, nominally 50mm in from edge of board

C = Bottom flange stud welded pins at max. 320mm centres

D = Transverse joints in the side boards are offset with respect to those fixed to the flange by a minimum 100mm

E = $\leq 100\text{mm}$ Flange Width - 1 row of welded pins, $\geq 100\text{mm}$ Flange Width - 2 rows of pins required

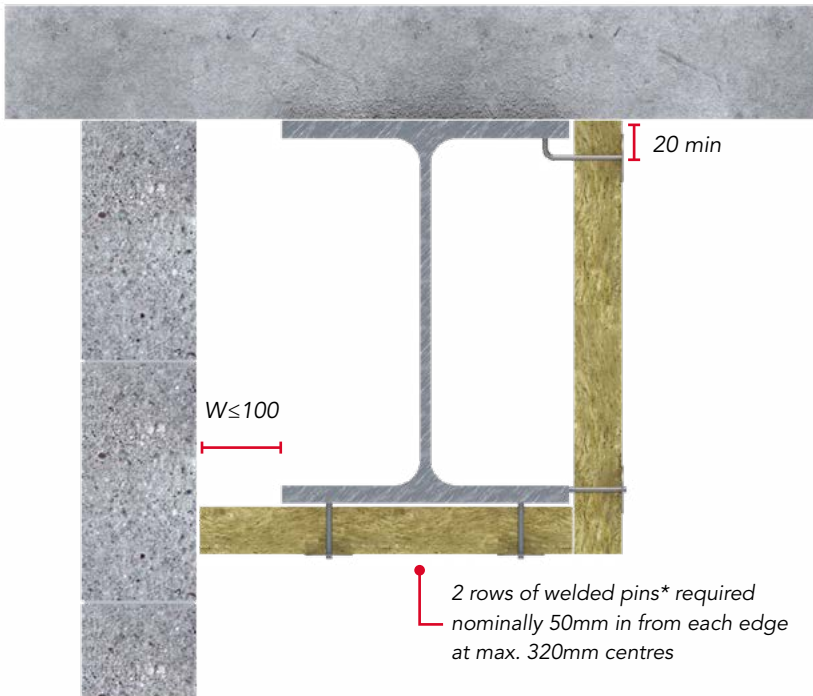


Figure 6
2-sided box

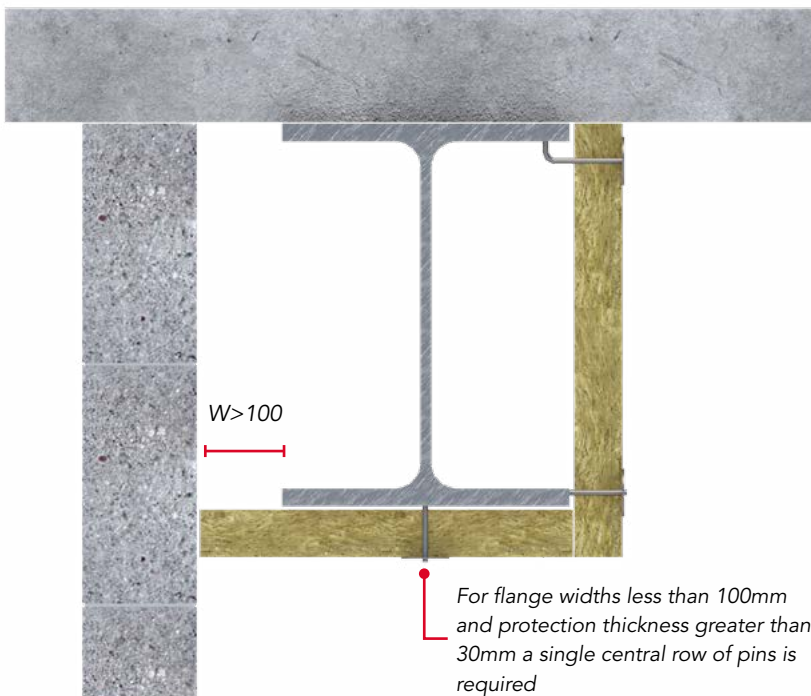


Figure 7
2-sided box - W limit is 100mm. Where $W > 100$ mm a shelf angle or similar should be fixed to the wall

* For flange widths greater than 100mm, 2 rows of pins are required, each row approx. 50mm from flange tips.



ROCKWOOL BeamClad glued joint systems

The following two systems are well established having been used for many years. The application of FirePro Glue enhances the fire performance over the dry joint systems for 2, 3 and 4 hour periods. The glue joint systems are capable of providing up to 4 hours fire protection.

Fixing boards to noggins

Wherever three or four-sided protection is required, fixing to noggins is a practical option. No power supply is required

Fixing boards with stud welded pins

Situations will always occur where noggins do not afford a practical choice, e.g. for two-sided box constructions or diverse perimeter bracketing.

Stud welded pins allow the installer a simple, tested alternative to noggins.

Installation sequence (noggin fix)

Fixing noggins

Cut 120mm wide noggins to suit web depth, using same thickness material as the cover protection. For web depths of 500mm and up to (C)600/(B)604mm* use either solid noggins or 'T' shaped noggins. For stability purposes, it is recommended that the face of the 'T' noggin is made from the same thickness as the cover board but the thickness of the return into the web should be at least 50mm. These are then glued into position at 1000mm centres.

Fixing boards

Apply FirePro Glue liberally to face of noggins. Quickly apply vertical boards and secure with nails/pigtail screws long enough to pierce full thickness of noggins before FirePro Glue forms a hardened surface.

Apply glue continuously and liberally to all board interfaces. Tightly butt to adjoining boards and nail/pigtail screw through edge joints with same length nails/pigtail screws as for noggins, at 400mm maximum centres.

* (C) denotes Column

* (B) denotes Beam

Installation sequence (stud welded pin fix)

1. Fit stud welded pins (2.7mm diameter).
2. A selection of pins should be mechanically tested by bending from the vertical and returning it to the original position.
3. 28mm sprung steel non-return washers to secure boards.
4. Apply FirePro Glue to all board-to-board joints.
5. Offer up flange boards and nail/pigtail screw through glued corner joints at 400mm maximum centres.
6. If using faced boards, apply foil or scrim tape over joints for uniformity of appearance.

For A/V charts, see Charts 1 and 2 (Stud Welded).

Typical details

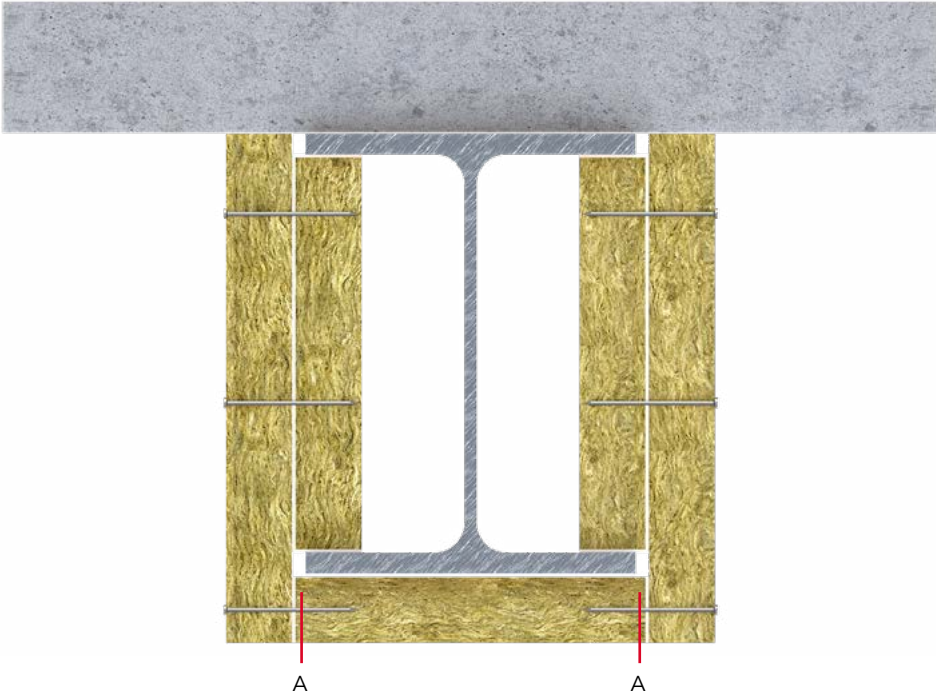


Figure 8
3-sided box, noggins to project slightly beyond flange

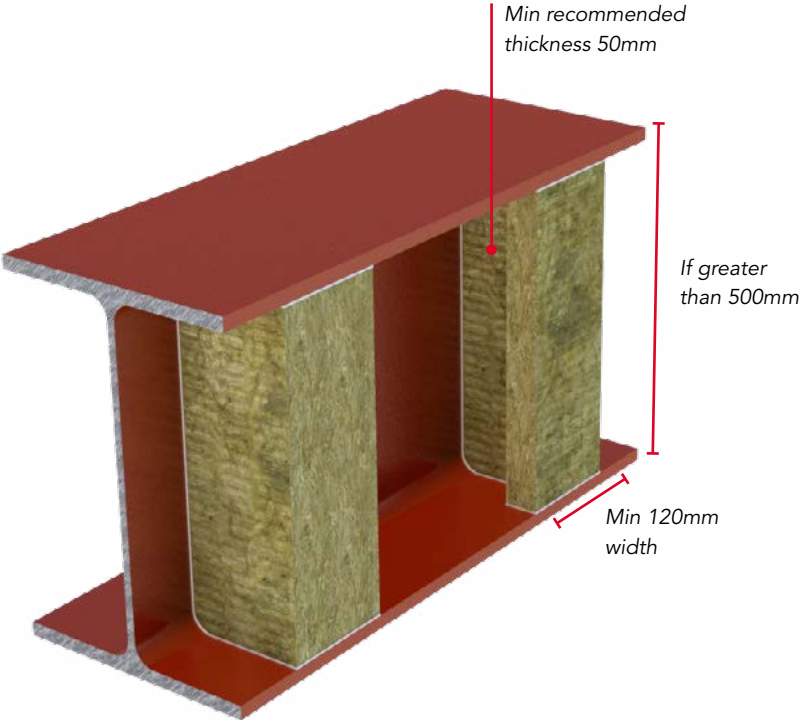


Figure 9
Full depth noggin or 'T' noggin for web depths greater than 500mm, up to 604mm for beams and 600mm for columns



Fixing patterns

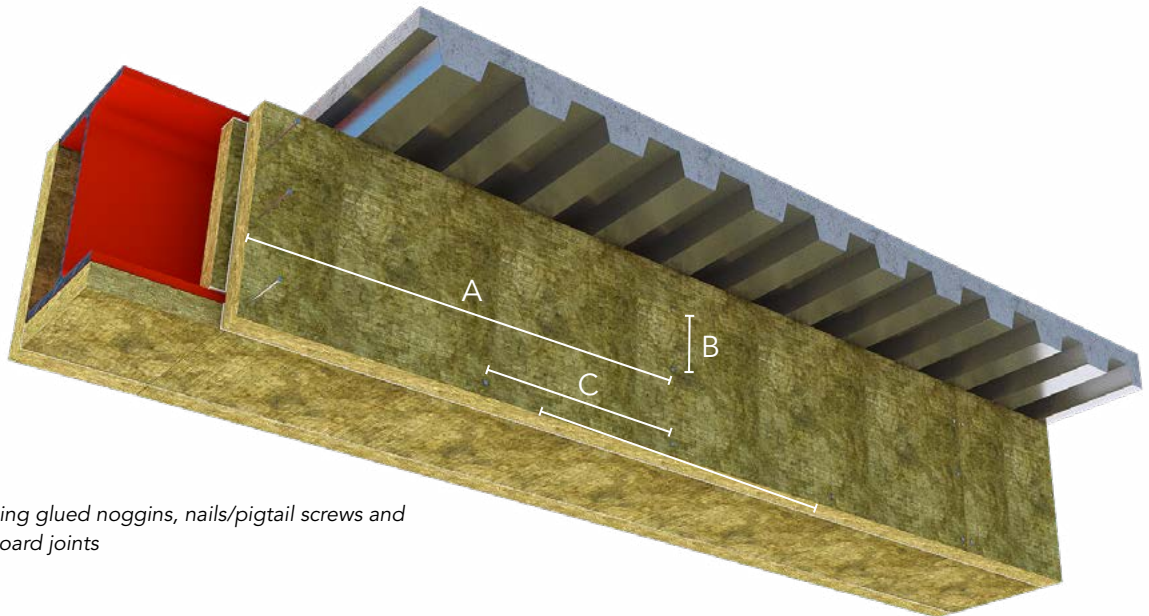


Figure 10

Fixing method using glued noggins, nails/pigtail screws and glued board-to-board joints

Dimensions

A = Noggins at max. 1000mm centres

B = Nails/pigtail screws at max. 150mm centres

C = Nails/pigtail screws at max. 400mm centres (max. 50mm from edge of board joint)

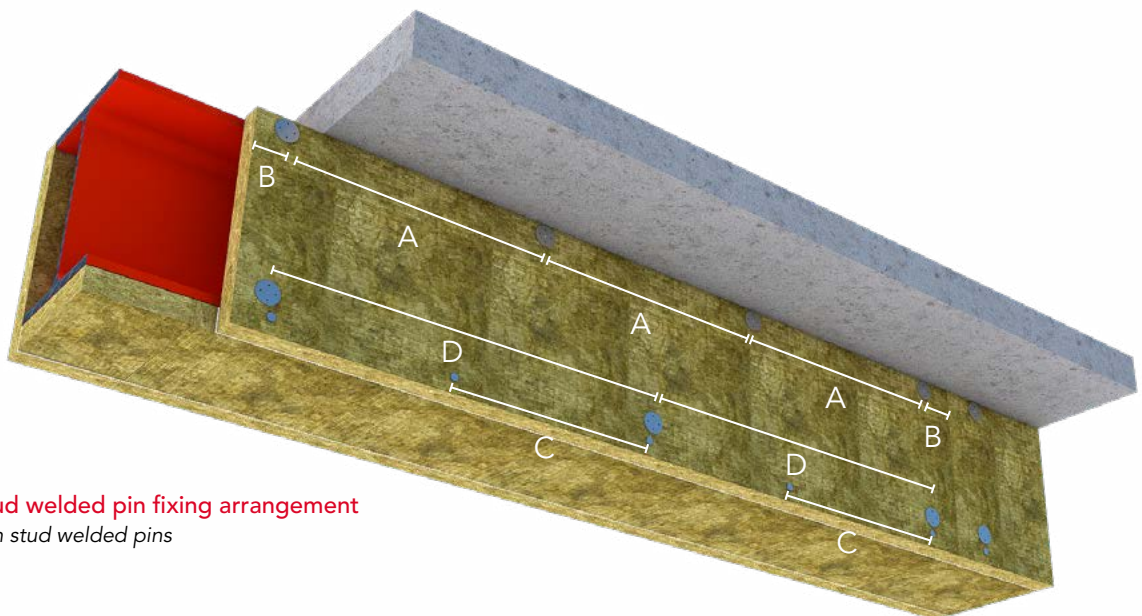


Figure 11 - Stud welded pin fixing arrangement

3-sided box with stud welded pins

Dimensions

A = Stud welded pins at 320mm centres

B = Stud welded pins at max. 50mm from edge of board

C = Nails at max. 400mm centres

D = Stud welded pins at 320mm centres

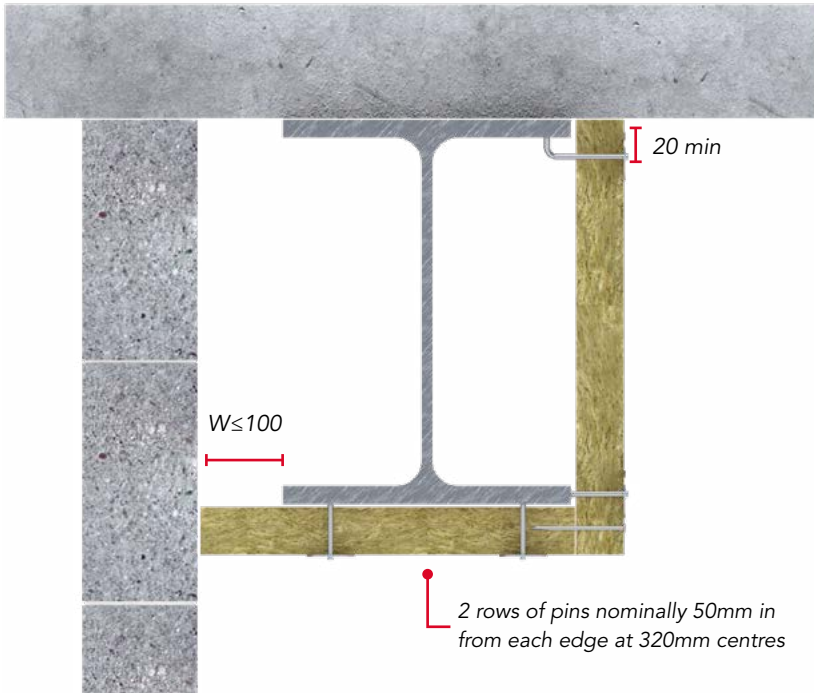


Figure 12
2-sided box

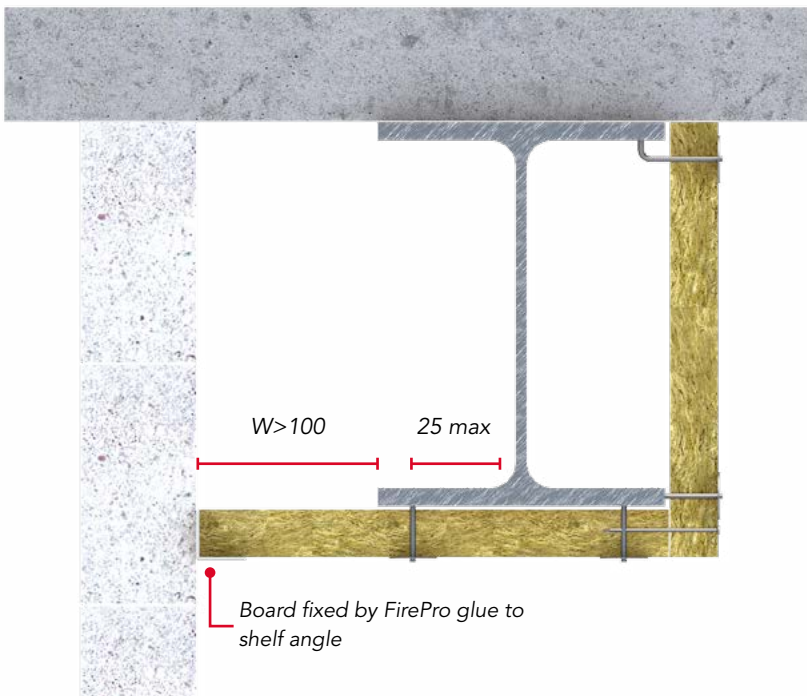


Figure 13
2-sided box - W. Limit is 100mm. For $W > 100$ mm, a shelf angle or similar should be fixed to the wall

* For flange widths greater than 100mm, 2 rows of pins are required, each row approx. 50mm from flange tips.



Chart 3 - Steel beam sections ROCKWOOL BeamClad glued joint systems:
Critical steel temperature 620°C

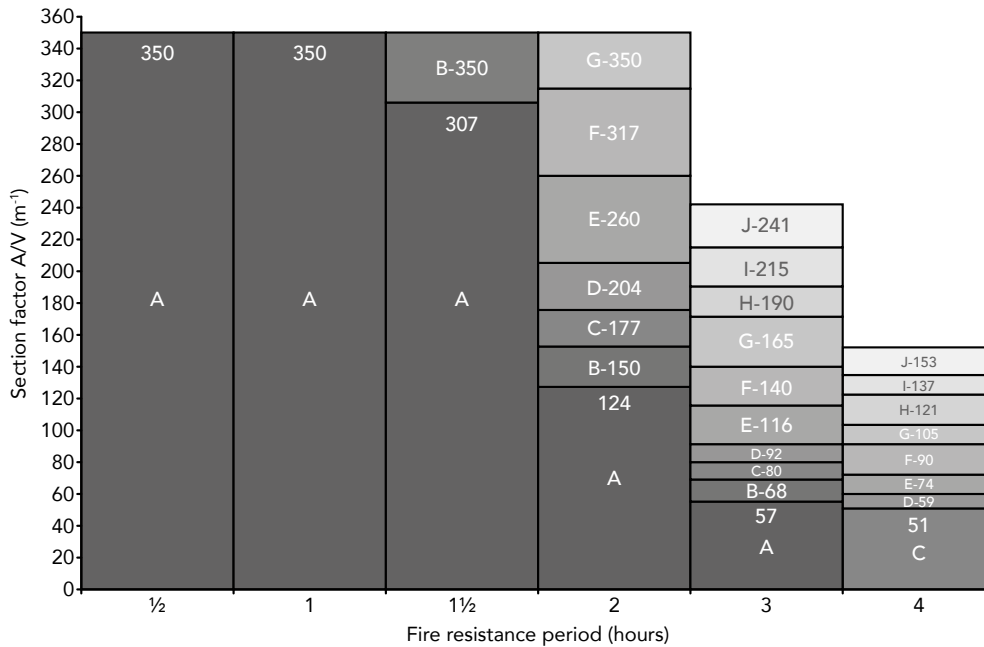
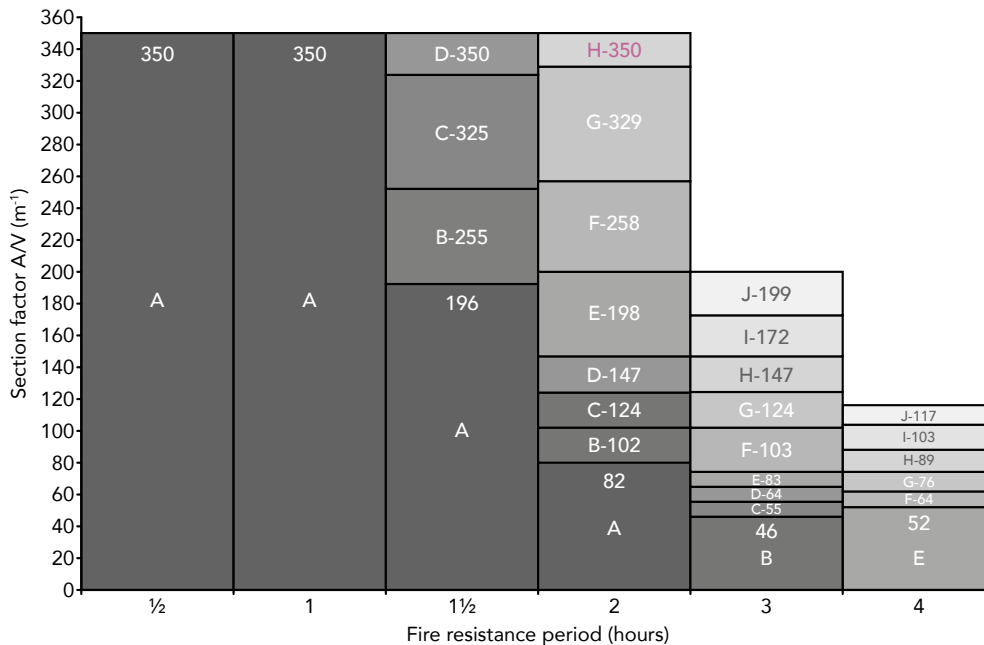


Chart 4 - Steel beam/column sections ROCKWOOL BeamClad glued joint systems:
Critical steel temperature 550°C



The following key provides the required minimum thicknesses of ROCKWOOL BeamClad for the Section Factors given in the tables above.

- A = 25mm
- B = 30mm
- C = 35mm
- D = 40mm
- E = 50mm
- F = 60mm
- G = 70mm
- H = 80mm
- I = 90mm
- J = 100mm

Column applications

The fixing system for columns is the same as for beams except that only a single row of pins are required down then centre of the web where the web width is less than 120mm and the protection thickness is 30mm or greater.

Where stud weld pins are used, the boards across the web should be fixed to the noggins using nails/pigtail screws.

Board jointing options

Butted corner joints

Butted corner joints are made with square edge boards using either a dry joint, or FirePro Glue and nails/pigtail screws at 400mm centres.

Axial joints

All axial joints are made with square butt edges, without nails. Glue is only required for glued board systems. For Foil faced products, joints can be finished with Class 'O' foil tape.

Noggins

ROCKWOOL BeamClad boards can be fixed to noggins, cut from ROCKWOOL BeamClad offcuts of at least the same thickness as the fascia and soffit boards.

The edges of the noggins are glued where they contact the steelwork. Once the noggins have set firmly, the cover boards are fixed in position with FirePro Glue and nails/pigtail screws. The thickness of the noggin is to be the same as that of the cover board used.

Welded steel pins

Boards are secured to 2.7mm diameter stud welded pins with 28mm diameter non-return washers.

Glue

FirePro Glue is required between all board-to-board and board-to-noggin joints for glued systems.

Applying FirePro Glue on the external face of joints is bad practice.

Whatever noggin system is employed, the glue between noggin and steel must be allowed to set hard before cover boards are applied to the noggins. This will normally take about 4 hours at 20°C ambient temperature.

FirePro Glue is supplied pre-mixed in 17kg tubs and 300ml cartridges.

Coverage rate will depend on the linear length of the joints, width of joint (board thickness) and joint depth. Assuming total, effective useage of the glue on site, the following table provides an approximate weight (kg) of glue per linear metre of joint, based on a glue depth of 1mm.

In practice, a degree of wastage would be expected and as such, it would be prudent to make an allowance for this when placing an order. As a very approximate guide, the coverage rate of a 17kg tub of FirePro Glue would be 35m² of applied board.

Figure 29

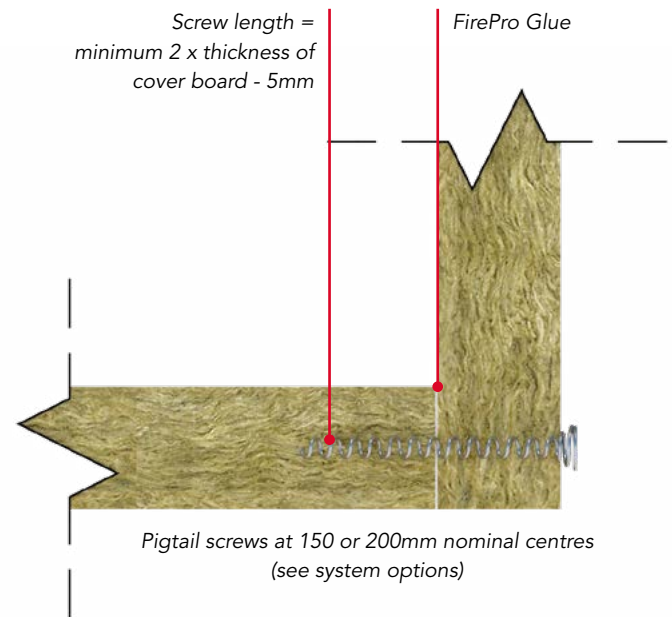


Figure 30

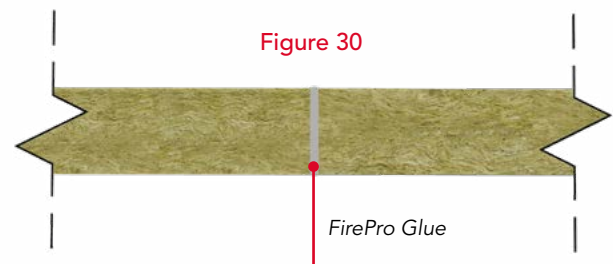


Table 1

ROCKWOOL BeamClad thickness (mm)	Square butt joint
25	0.09
30	0.11
35	0.13
40	0.15
50	0.19
60	0.22



Section Factor H_p/A

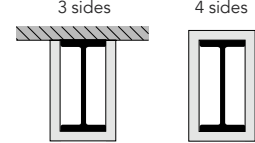
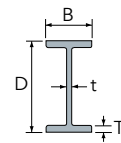


Table 2: Universal beams A/V table (as per 2006)

Designation serial size	Mass per metre (kg)	Depth per section D (mm)	Width per section B (mm)	Thickness web t (mm)	Flange T (mm)	Area of section (cm ²)	m ⁻¹	m ⁻¹
914x419	388	921.0	420.5	21.5	36.6	494.5	45	55
	343	911.4	418.5	19.4	32.0	437.5	50	60
914x305	289	926.6	307.8	19.6	32.0	368.8	60	65
	253	918.5	305.5	17.3	27.9	322.8	65	75
	224	910.3	304.1	15.9	23.9	285.3	75	85
	201	903.0	303.0	15.2	20.2	256.4	80	95
838x292	226	850.9	293.8	16.1	26.8	288.7	70	80
	194	840.7	292.4	14.7	21.7	247.2	80	90
	176	834.9	291.6	14.0	18.8	224.1	90	100
762x267	197	769.6	268.0	15.6	25.4	250.8	70	85
	173	762.0	266.7	14.3	21.6	220.5	80	95
	147	753.9	265.3	12.9	17.5	188.1	95	110
686x254	170	692.9	255.8	14.5	23.7	216.6	75	90
	152	687.6	254.5	13.2	21.0	193.8	85	95
	140	683.5	253.7	12.4	19.0	178.6	90	105
	125	677.9	253.0	11.7	16.2	159.6	100	115
610x305	238	633.0	311.5	18.6	31.4	303.8	50	60
	179	617.5	307.0	14.1	23.6	227.9	70	80
	149	609.6	304.8	11.9	19.7	190.1	80	95
533x210	122	544.6	211.9	12.8	21.3	155.8	85	95
	109	539.5	210.7	11.6	18.8	138.6	95	110
	101	536.7	210.1	10.9	17.4	129.3	100	115
	92	533.1	209.3	10.2	15.6	117.8	110	125
	82	528.3	208.7	9.6	13.2	104.4	120	140
457x191	98	467.4	192.8	11.4	19.6	125.3	90	105
	89	463.6	192.0	10.6	17.7	113.9	100	115
	82	460.2	191.3	9.9	16.0	104.4	105	125
	74	457.2	190.5	9.1	14.5	95.0	115	135
	67	453.6	189.9	8.5	12.7	85.4	130	150
457x152	82	465.1	153.5	10.7	18.9	104.5	105	120
	74	461.3	152.7	9.9	17.0	95.0	115	130
	67	457.2	151.9	9.1	15.0	85.4	125	145
	60	454.7	152.9	8.0	13.3	75.9	140	160
	52	449.8	152.4	7.6	10.9	66.5	160	180
406x178	74	412.8	179.7	9.7	16.0	95.0	105	125
	67	409.4	178.8	8.8	14.3	85.5	115	140
	60	406.4	177.8	7.8	12.8	76.0	130	155
	54	402.6	177.6	7.6	10.9	68.4	145	170
406x140	46	402.3	142.4	6.9	11.2	59.0	160	185
	39	397.3	141.8	6.3	8.6	49.4	190	215
356x171	67	364.0	173.2	9.1	15.7	85.4	105	125
	57	358.6	172.1	8.0	13.0	72.2	120	145
	51	355.6	171.5	7.3	11.5	64.6	135	160
	45	352.0	171.0	6.9	9.7	57.0	150	180
356x127	39	352.8	126.0	6.5	10.7	49.4	165	195
	33	348.5	125.4	5.9	8.5	41.8	195	225
305x165	54	310.9	166.8	7.7	13.7	68.4	115	140
	46	307.1	165.7	6.7	11.8	58.9	135	160
	40	303.8	165.1	6.1	10.2	51.5	150	185
305x127	48	312.7	102.4	6.6	10.8	41.8	175	200
	42	308.9	101.9	6.1	8.9	36.3	200	230
	37	304.8	101.6	5.8	6.8	31.4	225	255
254x146	43	259.6	147.3	7.3	12.7	55.1	120	150
	37	256.0	146.4	6.4	10.9	47.5	140	170
	31	215.5	146.1	6.1	8.6	40.0	165	200
254x102	28	260.4	102.1	6.4	10.0	36.2	175	200
	25	257.0	101.9	6.1	8.4	32.2	190	225
	22	254.0	101.6	5.8	6.8	28.4	220	255
203x133	30	206.8	133.8	6.3	9.6	38.0	145	180
	25	203.2	133.4	5.8	7.8	32.3	170	210

Determining protection thickness

The table opposite indicates the effect on A/V for three and four sided schemes Determine A/V factor from the table or by calculating for other exposure situations, ensuring the correct mass per metre is used.

Establish the period of fire protection required.

For A/V factors in excess of 300, contact ROCKWOOL for advice on both thicknesses and fixing methods preferred.

Bracing members: These do not generally require protection. If required as an essential element to the fire resistance, use A/V not greater than 200 m⁻¹.

Where steel beams are fixed to composite steel and concrete decks, the profiled re-entrant void may not need additional protection if allowances for board thickness or steelwork section factor are made.

See the ASFP Yellow Book A.3.5 for current independent guidance.

Profiled re-entrant voids above steel beams will need to be infilled-

- Where steel beams are positioned to form a continuation of a compartment wall
- Where non-composite beams support a trapezoidal steel deck

FirePro Linear and Trapezoidal FireStop Systems have been developed to provide up to 4 hours fire stopping at the junctions of compartment walls and floors and can be manufactured to suit the trapezoidal/dovetail profile.

General notes for systems

Ensure steel is free from grease, dust or loose particles where noggins are to be glued or pins welded.

Dry off steelwork where large water droplets are present. Steel damp to the touch is acceptable.

Ensure that all noggins have the correct friction fit. Avoid excessive interference that may cause noggins to bend.

Fix additional noggins (if required) at beam ends, beam-to-beam joints and large penetrations. For stud welded pin systems it may be necessary to introduce soldier noggins into webs behind board to board joints to increase stability of the system on steelwork with large web depths (up to 603mm).

For glued system options ensure that all noggin-to-beam, noggin to-board and board-to-board surfaces are glued, and that the required setting time is allowed.

Remove any excess glue for neatness.

Any localised board shaping to be made at the point of installation should be carried out with a sharp knife or fine-toothed saw.

Avoid 'nuisance dust' from cutting operations lying on boards prior to installation Always use sharp-edged cutting tools.

The length of all nails used should be at least twice the thickness of the board being fixed.

Pigtail screw length should be twice the thickness of the board being fixed, less 5mm.

All board to board joints must be tightly butted.

Vapour barriers

Glass-reinforced aluminium foil-faced ROCKWOOL BeamClad A/F provides an excellent vapour seal. For integrity of the foil, all edges should be taped (with a minimum 75mm wide) plain foil tape. Idenden T 303 tape is recommended as being suitable. Taped joints also prevent damage to foil edges during construction.

Board joints (glued)

No glue is required where boards meet wall or soffit surfaces, except in cases where a temporary fix to flange faces may be advantageous to the work sequence. Close contact between boards at joints is always essential.

Painted steel

Painting of structural steelwork is not always essential for corrosion protection. BS 8202: Part 1: 1995 permits the use of unpainted steel which is both interior to the building and in an area which will be constantly heated.

ROCKWOOL BeamClad thickness

In selecting ROCKWOOL BeamClad thicknesses, due consideration must be given to the required period of fire resistance and the A/V value of the steel sections concerned.

Supply

ROCKWOOL BeamClad slabs are supplied on pallets, shrink-wrapped in polyethylene. Pigtail screws are available from ROCKWOOL stockists. Welded pins and sprung steel non-return washers are available from external suppliers.

References

ROCKWOOL BeamClad systems are part of the ROCKWOOL FirePro range of fire stopping and fire protection range. A range of building solutions to prevent fire spread and protect the structural integrity of the building.



Section 2 – Building services

Building services are an essential part of nearly every building, whether it's the distribution of cold and warm air through HVAC systems or providing active measures of fire protection through sprinkler systems they play an important role in all building types.

As building services often reach out to all parts of a building it is common for these services to pass through compartment walls and floors. In addition, some building services like smoke extract systems or sprinkler systems provide active measures of fire protection which often require their own level of fire resistance.

Ensuring that building services can operate safely and do not contribute towards the spread of fire within the building are key considerations for any fire safety strategy.

ROCKWOOL provide a range of products which have been specially designed for fire protecting ductwork systems, sprinkler and service pipes for periods up to 2 hours on ductwork and 4 hours on service pipes.



FirePro DuctRock

Core products



RockLap H&V Pipe Sections



FirePro DuctRock

Useful documents and standards

ASFP Technical Guidance Document – TGD 18: Code of practice for the installation & inspection of fire resisting duct systems

ASFP Blue Book: Fire Resisting Ductwork

ASFP Grey Book: Fire and smoke resisting dampers

ASFP: Ensuring best practice for passive fire protection in buildings

BS 476-24: Fire test on building materials and structures. Method for determination of the fire resistance of ventilation ducts

BS EN 1366-1: Fire resistance test for service installations. Ventilation ducts

BS EN 1366-8: Fire resistance test for service installations. Smoke extraction ducts

BS EN 1363-1: Fire resistance tests. General requirements

BS EN 13501-3: Fire classification using test data from resistance to fire tests on products and elements used in building service installations. Fire ducts and dampers

BS EN 13501-4: Fire classification using test data from resistance to fire tests on components of smoke control systems

ASFP (Association for Specialist Fire Protection) guidance documents can be sourced at www.asfp.org.uk



RockLap H&V Pipe Sections

For rapid, efficient pipework insulation



RockLap H&V Sections are pre-formed sections of stone wool insulation. Manufactured pre-slit and provided with a factory applied foil facing complete with integral self-adhesive lap.

Sizes available: Please see the table on page 11.

- Resilient, high performance barrier provided by one-piece, reinforced foil with integral lap
- Fast and simple installation reduces costs and time on site
- Tape requirement reduced
- Tested to EN 1366-3, for the fire resistance of penetration seals offering up to EI 120*

*Subject to the application

RockLap H&V Pipe Sections are designed for thermal and acoustic insulation of heating, ventilation and air-conditioning pipework operating in the temperature range 0°C to 250°C.

The sections are provided with a factory applied foil facing and self-adhesive lap which ensures easy installation.

APPLICATIONS

RockLap H&V Pipe Sections are strong lengths of pre-formed insulation with a one piece, factory applied foil facing with integral self-adhesive lap. The integral lap ensures fast and easy installation: just snap the sections onto the pipe, peel off the backing tape and smooth down for a completely sealed joint.

ROCKWOOL H&V Pipe Sections have been successfully tested for providing fire stopping to steel & copper pipe penetrations where they penetrate fire resistant walls and floors.

The H&V pipe sections are suitable for use within fire rated flexible/rigid walls and concrete floors either as sleeving (Locally sustained – L/S) where they penetrate the division or with continuous insulation (Continually sustained – C/S) along the length of the pipework.

This allows for H&V pipe sections used for thermal insulation to pipework to be continued through fire resistant constructions without the need to be locally removed or replaced thus saving time and reducing labour costs.

PERFORMANCE

Thermal performance

The specific heat of ROCKWOOL stone wool is 0.84 kJ/kgK (nom.) at 20°C.

Temperature °C	*Curve 1 (W/mK)	*Curve 2 (W/mK)
10	0.033	0.034
50	0.037	0.039
100	0.044	0.048
150	0.052	0.056

*The thermal conductivity curve used depends upon the size of the pipe section. For further information please refer to the DOP.

Note - Due to the low emissivity of aluminium, heat losses, which depend upon the diameter, thickness and temperature of the pipe to be insulated, are reduced by approx. 9% by using aluminium faced sections compared with painted or PVC faced sections.

Consider a 169 mm O.D. hot water pipe running at 75°C with an ambient temperature of 15°C insulated with 50 mm thick RockLap H&V Pipe Section:

Cladding type	Emissivity (ε)	Outer surface temp (°C)	Heat loss (W/m)
Aluminium	0.05	24.4	27
Cloth	0.90	19.5	29





Table 8 (BS5422:2009)

Minimum thickness of ROCKWOOL RockLap H&V to prevent condensation.
Taken from BS 5422 Table 8, ambient air temperature 25°C, 80% rh, $\epsilon=0.05$

Outside diameter of steel pipe on which insulation has been based (mm)	Temperature of contents (°C)					
	Temperature of contents +10°C		Temperature of contents +5°C		Temperature of contents 0°C	
	Calculated thickness (mm)	Advised thickness (mm)	Calculated thickness (mm)	Advised thickness (mm)	Calculated thickness (mm)	Advised thickness (mm)
17	15.7	20	21.8	25	27.5	30
21	16.9	20	23.1	25	29.4	30
27	18.2	20	25.0	25	31.8	35
33	19.5	20	26.8	30	33.8	35
42	20.9	25	28.9	30	36.4	40
48	21.7	25	30.1	35	37.9	40
60	23.1	25	32.2	35	40.6	45
76	25.7	30	35.7	40	44.9	45
89	26.9	30	37.4	40	47.2	50
102	28.0	30	38.9	40	49.5	50
114	28.9	30	40.2	45	51.2	55
140	30.6	35	42.3	45	54.1	55
169	32.3	35	44.9	45	57.1	60
219	34.6	35	48.4	50	61.2	65
245	35.6	40	50.0	50	63.2	65
273	36.7	40	51.2	55	65.2	70
324	38.3	40	53.5	55	68.5	70
356	39.2	40	54.8	55	70.3	75
406	40.6	45	56.7	60	73.5	75
456	41.4	45	58.5	60	75.0	75
508	42.6	45	60.2	65	77.9	80
558	43.7	45	61.7	65	79.1	80
610	44.7	45	63.1	63	80.9	81

Table 15 (BS5422:2009)

Indicative thickness of insulation for non-domestic heating services to control heat loss – low emissivity outer surfaces ($\epsilon=0.05$).

Outside diameter of steel pipe on which insulation has been based (mm)	Hot face temperature (°C)								
	Thickness of ROCKWOOL RockLap H&V Pipe Section (mm)								
	75			100			125		
Heat gain (W/m)	Calculated thickness (mm)	Advised thickness (mm)	Heat gain (W/m)	Calculated thickness (mm)	Advised thickness (mm)	Heat gain (W/m)	Calculated thickness (mm)	Advised thickness (mm)	
17.2	28	30	8.9	28	30	13.34	29	30	17.92
21.3	32	35	9.28	34	35	13.56	35	35	18.32
26.9	35	35	10.06	43	45	13.83	43	45	18.7
33.7	37	40	11.07	50	50	14.39	54	55	19.02
42.4	39	40	12.3	54	55	15.66	67	70	19.25
48.3	41	45	12.94	55	55	16.67	70	70	20.17
60.3	43	45	14.45	59	60	18.25	75	75	21.96
76.1	45	45	16.35	62	65	20.42	80	80	24.21
88.9	46	50	17.91	64	65	22.09	83	85	25.99
114.3	48	50	20.77	68	70	25.31	89	90	29.32
139.7	49	50	23.71	70	75	28.23	93	95	32.47
168.3	50	50	26.89	73	75	31.61	96	100	36.04
219.1	51	55	32.54	75	75	37.66	100	100	42.16
273	51	55	38.83	77	80	43.72	103	105	48.48

Note 1 - Insulation thicknesses in this table have been calculated according to BS EN ISO 12241:2008 using standardised assumptions: horizontal pipe in still air at 15°C, emissivity of outer surface of insulated system as specified.

Note 2 - Heat loss relates to the specified thickness and temperature.

Note 3 - The thicknesses in this table are applicable to pipes serving commercial solar hot water panels.



Fire performance

RockLap H&V Pipe Sections are rated Euroclass A2L*-s1,d0.

RockLap H&V Pipe Sections have been tested for fire resistance to EN 1366-3, the harmonised European standard for the fire resistance of penetration seals.

RockLap H&V Pipe Sections provide up to 120 minutes** fire resistance integrity and insulation ratings. Use the links below to access further information on fire performance:

[Fire Stopping Standard Details Guide >](#)

*Classifications for linear pipe thermal insulation products are followed by the sub-index 'L' (for example, A2L).

**Subject to the application

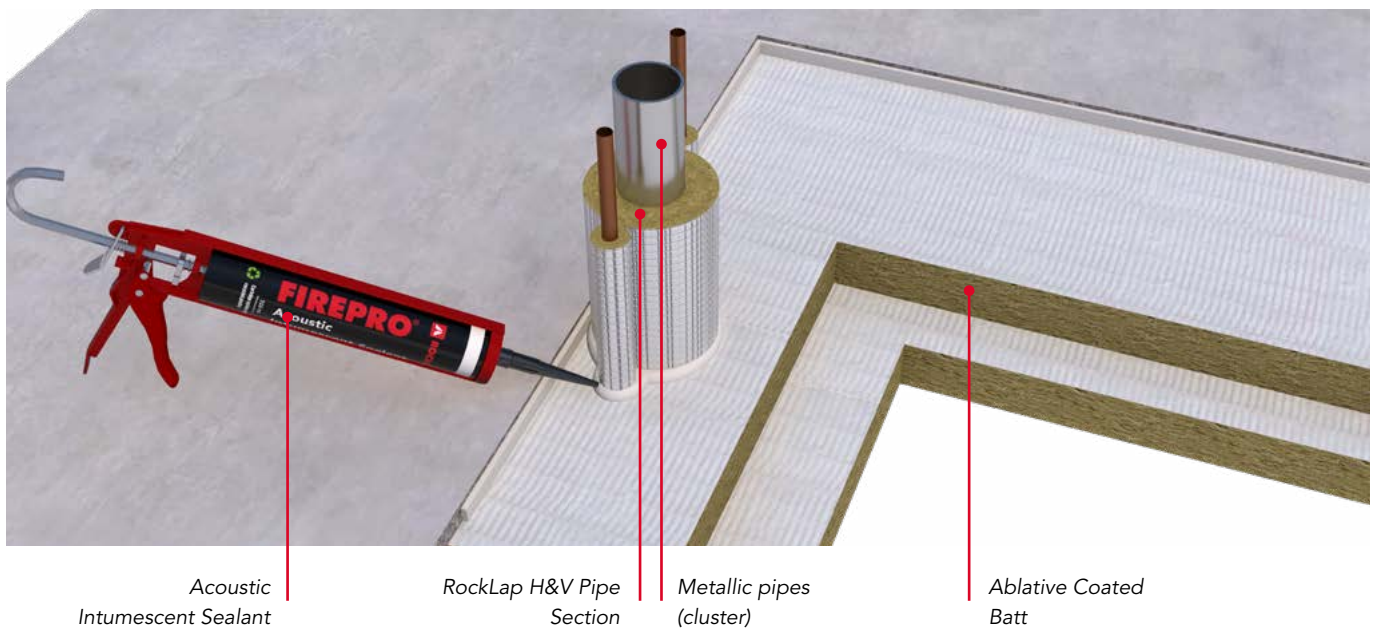


Table 1 - Performance of Insulated Steel & Copper Pipework in 150mm Aerated Concrete Floors

Insulation thickness (mm)	Pipe dia range (mm)	Formation	Substrate	Service separation (mm)	Substrate separation (mm)	Fire resistance (min)			
						Locally sustained (L/S)		Continuously sustained (C/S)	
						Integrity (E)	Insulation (I)	Integrity (E)	Insulation (I)
25mm H&V	42 - 169*	Cluster Single	2 x 50mm Ablative Coated Batt	0	0	240	120	240	120
25mm H&V	169-219**	Single	2 x 50mm Ablative Coated Batt	100	0	240	90	240	90
40mm H&V	42 - 169*	Cluster Single	2 x 50mm Ablative Coated Batt	0	0	180	60	180	120
40mm H&V	169-219**	Single	2 x 50mm Ablative Coated Batt	100	0	180	120	180	120

*Copper pipe sizes covered: 42-108mm / Steel pipe sizes covered: 42-169mm

**169-219mm covered for steel pipes only

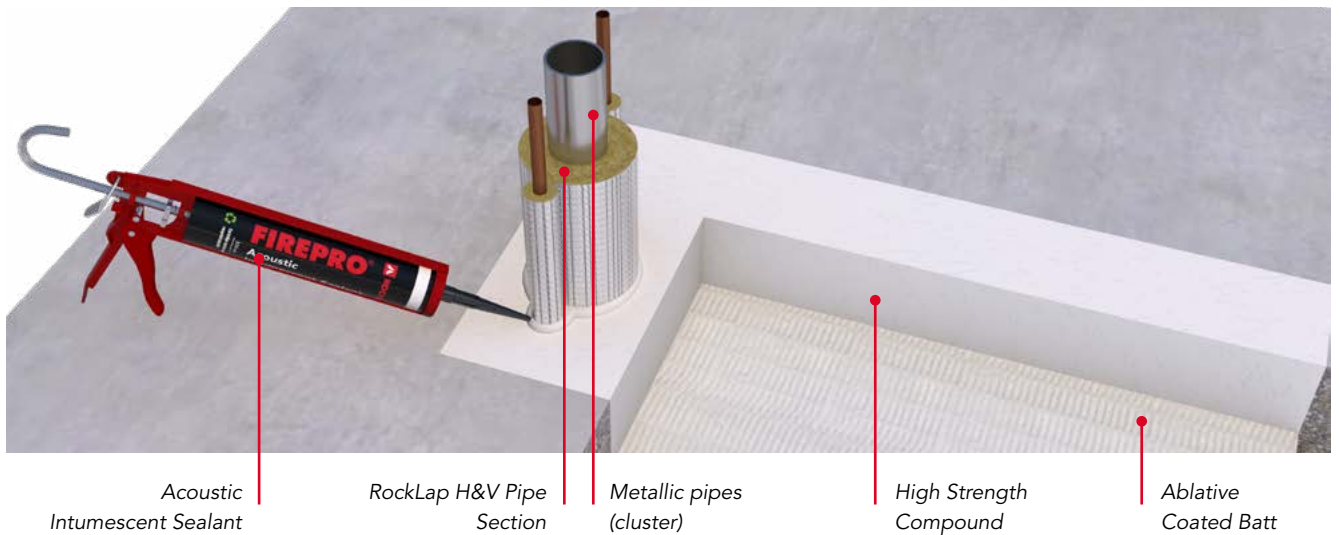


Table 2

Insulation thickness (mm)	Pipe dia range (mm)	Formation	Substrate	Service separation (mm)	Substrate separation (mm)	Fire resistance (min)			
						Locally sustained (L/S)		Continuously sustained (C/S)	
						Integrity (E)	Insulation (I)	Integrity (E)	Insulation (I)
25mm H&V	42 - 169	Cluster*	100mm HS Compound & 50mm ACB Shuttering	0	0	180	90	180	120
40mm H&V	42 - 169	Cluster*	100mm HS Compound & 50mm ACB Shuttering	0	0	240	60	240	180

*Copper pipe sizes covered: 42-108mm / Steel pipe sizes covered: 42-169mm

Table 3 - Performance of Steel & Copper Pipework in Flexible Wall (minimum 75mm) - Ablative Coated Batt (ACB)

Insulation thickness (mm)	Pipe dia range (mm)	Formation	Aperture	Service type	Service/substrate separation (mm)	Supporting construction	Classification E/I
> 25mm H&V	40 - 168*	Cluster	1 x 50mm ACB	Steel/Copper	0	75mm flexible wall	60/60

*Copper pipe sizes covered: 40-108mm / Steel pipe sizes covered: 40-168mm

Table 4 - Performance of Steel Pipework in Solid Wall (minimum 100mm) - Ablative Coated Batt (ACB)

Insulation thickness (mm)	Pipe dia range (mm)	Formation	Aperture	Service type	Service/substrate separation (mm)	Supporting construction	Application	Classification E/I
> 40mm H&V	< 610mm	Single	2 x 50mm ACB	Steel	100/0	100mm aerated block	Locally sustained (L/S)	120/600
> 40mm H&V	< 610mm	Single	2 x 50mm ACB	Steel	100/0	100mm aerated block	Continuously Sustained (C/S)	120/120

RockLap H&V Pipe Sections Ancillaries

- FirePro Acoustic Intumescent Sealant, Ablative Coated Batt & FireStop Compound are available from ROCKWOOL stockists
- RockLap Pipe Supports are suitable for use with RockLap H&V pipe sections and are available from all ROCKWOOL stockists
- Suitable aluminium foil tape is available from specialist HVAC stockists



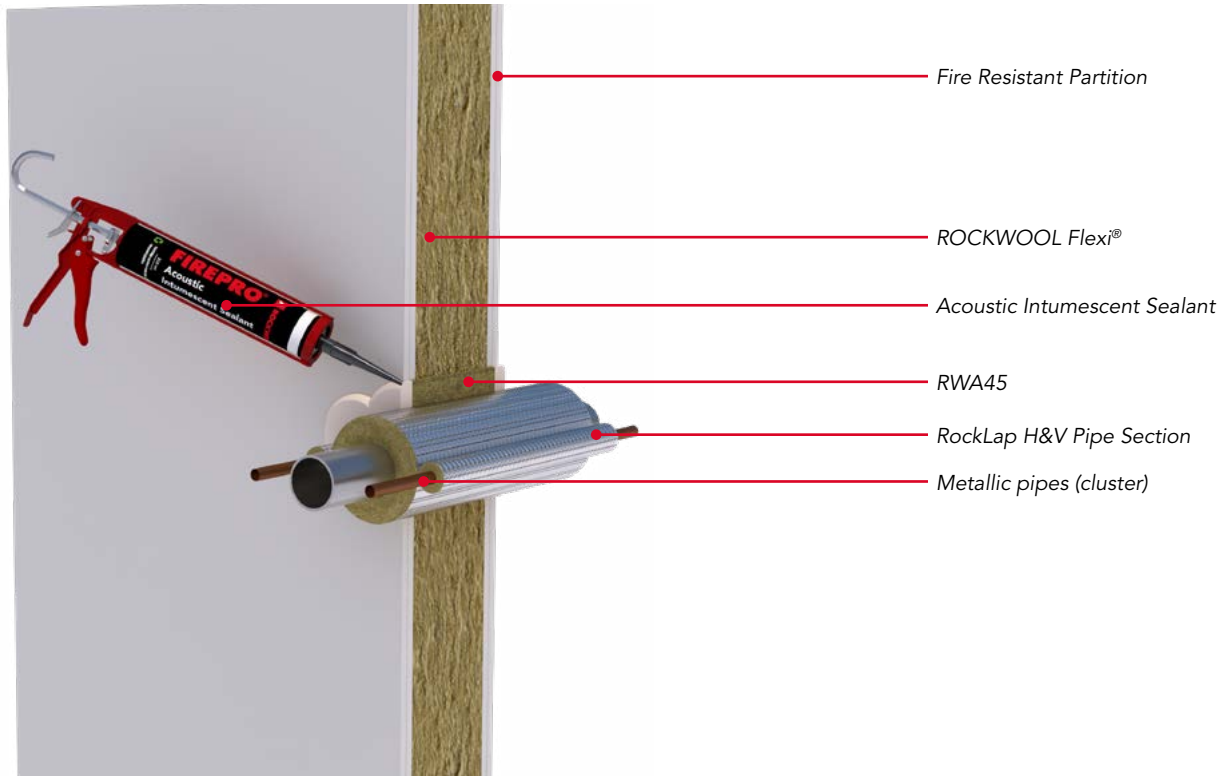


Table 5

Performance of Steel & Copper Pipework in Flexible and Solid Wall - Directly through fire rated wall construction

Insulation thickness (mm)	Pipe dia range (mm)	Formation	Aperture	Service type	Annular gap	Service/substrate separation (mm)	Classification					
							Locally sustained (L/S)			Continuously sustained (C/S)		
							Integrity (E)	Insulation (I)	E/I	Integrity (E)	Insulation (I)	E/I
> 20mm H&V	15	Single	Direct	Copper	<10mm *	0	120	120	120/120	120/120	120	120/120
> 20mm H&V	60	Single	Direct	Steel	<10mm*	0	120	120	120/120	120/120	120	120/120
> 20mm H&V	15	Single	Direct	Copper	<10mm *	0	120	120	120/120	120/120	120	120/120
> 25mm H&V	15	Single	Direct	Copper	11-50mm**	0	120	120	120/120	120	120	120/120
> 25mm H&V	16-108	Single	Direct	Copper	<10mm*	0	120	60	120/120	120	120	120/120
> 25mm H&V	16-108	Single	Direct	Copper	11-50mm**	0	120	90	120/120	120	120	120/120
> 25mm H&V	16-108	Cluster	Direct	Copper	< 50mm**	0	120	60	120/120	120	120	120/120
> 25mm H&V	114	Single	Direct	Steel	<10mm*	0	120	90	120/120	120	120	120/120
> 25mm H&V	114	Single	Direct	Steel	11-50mm**	0	120	90	120/90	120	120	120/120
> 25mm H&V	114-219	Single	Direct	Steel	<10mm*	0	90	90	90/90	90	90	90/90
> 25mm H&V	114-219	Single	Direct	Steel	11-50mm**	0	120	60	120/60	120	90	120/90
> 25mm H&V	15-114	Cluster	Direct	Steel	< 50mm**	0	120	120	120/120	120	120	120/120

* < 10mm = annular space sealed with AIS through full wall thickness

** 11-50mm Annular space filled with RWA45 and finished with 12.5mm AIS

PRODUCT INFORMATION

Water resistance

RockLap H&V Pipe Sections are water repellent. However, when used or stored in the open, the insulation should be protected with a waterproof covering. When used to insulate cold pipes, the joints should be sealed with foil tape to prevent condensation.

Service temperature

RockLap H&V Pipe Sections are used to insulate pipes operating at temperatures in the range 0 to 250°C. The sections are used to insulate against frost damage. For hot pipes, the limiting temperature of the outer foil face is 80°C to maintain facing bond strength.

Durability

ROCKWOOL stone wool insulation products are highly resilient, durable and dimensionally stable, maintaining their thickness and shape over time. In tests, ROCKWOOL insulation has shown to retain its insulation characteristics and properties for more than 55 years after initial installation.

Biological

ROCKWOOL stone wool is a naturally inert and rot-proof material that does not encourage or support the growth of fungi, moulds or bacteria, or offer sustenance to insects or vermin.

STANDARDS AND APPROVALS

Certificate

ROCKWOOL H&V Pipe Sections are CE marked in accordance with BS EN 14303. For more information please visit www.rockwool.co.uk/DOP

RockLap H&V Pipe Sections conform to BS 3958-4, 'Bonded preformed stone wool pipe sections' and can be used to satisfy BS 5422: 'Method for specifying thermal insulating materials...'.
The product has been authorised for use in LUL surface and sub-surface premises when installed in accordance with this data sheet – please refer to the LUL Approved Product Register website www.LU-apr.co.uk for specific details.





INSTALLATION

RockLap H&V Pipe Sections are supplied with an integral self-adhesive overlap. Place the section around the pipe and seal accordingly (Figure 1).

All joints between RockLap sections must be sealed with aluminum foil tape (Figure 2).

Handling

RockLap H&V Pipe Sections are easy to cut to any shape with a sharp knife. When stored outside, avoid contact with the ground and cover with a securely anchored waterproof sheet.

Maintenance

Once installed RockLap H&V Pipe Sections shouldn't require any maintenance.

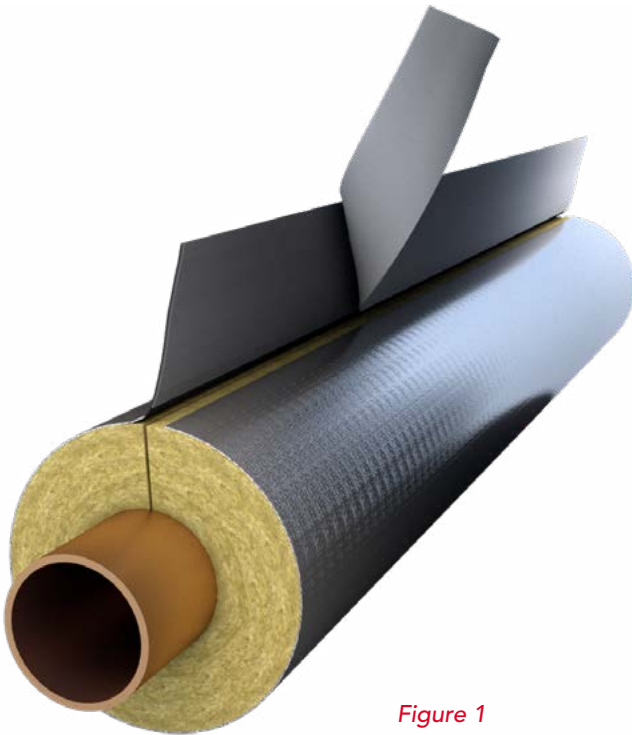


Figure 1



Figure 2

SPECIFICATION CLAUSES

Pipes to be insulated with *mm thick ROCKWOOL RockLap H&V Pipe Sections, having a nominal density not less than 120kg/m³, with a factory applied facing which is a laminate of close mesh reinforcement between two layers of foil including integral lap for fixing. The whole to comply with BS 5422:2009 and BS 5970 water vapour permeance and Building Regulation requirements in relation to thermal and fire. Fixing to be in accordance with manufacturer's instructions, by peeling protective tape from self-adhesive lap and pressing lap smoothly over joint. Where adjacent sections abut, approved 75 mm wide aluminium tape to be used to maintain integrity of the vapour barrier.

For external applications please see HVAC Specification Detail Guide for external finishes.

*insert required thickness

Other guidance

Available standard dimensions and packaging matrix.

To Suit Pipe O.D. / mm	Insulation Thickness / mm										
	20	25	30	35	40	45	50	60	70	80	100
17	42 (1)	30 (1)	25 (1)	20 (1)	16 (1)						
21	36 (1)	30 (1)	20 (1)	13 (1)	13 (1)	9 (1)	9 (1)				
27	30 (1)	25 (1)	20 (1)	12 (1)	12 (1)	9 (1)	9 (1)	6 (2)	4 (2)		
34	25 (1)	20 (1)	16 (1)	12 (1)	9 (1)	8 (1)	8 (1)	5 (2)	4 (2)		
42	20 (1)	16 (1)	12 (1)	9 (1)	9 (1)	6 (1)	6 (1)	4 (2)	4 (2)	■ (2)	■ (2)
48	16 (1)	16 (1)	12 (1)	9 (1)	9 (1)	6 (1)	6 (1)	4 (2)	■ (2)	■ (2)	■ (2)
54	16 (1)	12 (1)	10 (1)	8 (1)	8 (1)	5 (1)	5 (1)	4 (2)	■ (2)	■ (2)	
60	12 (1)	12 (1)	9 (1)	7 (1)	7 (1)	5 (1)	5 (1)	4 (2)	■ (2)	■ (2)	■ (2)
67		9 (2)	9 (2)	6 (2)	6 (2)	4 (2)	4 (2)	■ (2)	■ (2)	■ (2)	■ (2)
76		9 (2)	7 (2)	5 (2)	5 (2)	4 (2)	4 (2)	■ (2)	■ (2)	■ (2)	■ (2)
80		9 (2)	6 (2)	5 (2)	5 (2)	4 (2)	4 (2)	■ (2)	■ (2)	■ (2)	■ (2)
89		6 (2)	6 (2)	4 (2)	4 (2)	4 (2)	■ (2)	■ (2)	■ (2)	■ (2)	■ (2)
102		5 (2)	■ (2)	■ (2)	■ (2)	■ (2)	■ (2)	■ (2)	■ (2)	■ (2)	■ (2)
108		5 (2)	■ (2)	■ (2)	■ (2)	■ (2)	■ (2)	■ (2)	■ (2)	■ (2)	■ (2)
114		4 (2)	● (2)	■ (2)	■ (2)	■ (2)	■ (2)	■ (2)	■ (2)	■ (2)	■ (2)
127		4 (2)	● (2)	■ (2)	■ (2)	■ (2)	■ (2)	■ (2)	■ (2)	■ (2)	
133		● (2)	● (2)	■ (2)	■ (2)	■ (2)	■ (2)	■ (2)	■ (2)	■ (2)	■ (2)
140		● (2)	● (2)	■ (2)	■ (2)	■ (2)	■ (2)	■ (2)	■ (2)	■ (2)	■ (2)
150		● (2)	● (2)	■ (2)	■ (2)	■ (2)	■ (2)	■ (2)			
154		● (2)	● (2)	■ (2)	■ (2)	■ (2)	■ (2)	■ (2)	■ (2)	■ (2)	
159		● (2)	● (2)	■ (2)	■ (2)	■ (2)	■ (2)	■ (2)	■ (2)	■ (2)	■ (2)
169		● (2)	● (2)	■ (2)	■ (2)	■ (2)	■ (2)	■ (2)	■ (2)	■ (2)	■ (2)
178		● (2)	● (2)	■ (2)	■ (2)	■ (2)	■ (2)	■ (2)			
191		● (2)	● (2)	■ (2)	■ (2)	■ (2)	■ (2)	■ (2)			
194		● (2)	● (2)	■ (2)	■ (2)	■ (2)	■ (2)	■ (2)	■ (2)	■ (2)	■ (2)
205		● (2)	● (2)	■ (2)	■ (2)	■ (2)	■ (2)	■ (2)	■ (2)	■ (2)	■ (2)
219		● (2)	● (2)	■ (2)	■ (2)	■ (2)	■ (2)	■ (2)	■ (2)	■ (2)	■ (2)
230					■ (2)	■ (2)	■ (2)	■ (2)	■ (2)	■ (2)	■ (2)
245		● (2)	● (2)	■ (2)	■ (2)	■ (2)	■ (2)	■ (2)	■ (2)	■ (2)	■ (2)
253		● (2)	● (2)	■ (2)	■ (2)	■ (2)	■ (2)	■ (2)	■ (2)	■ (2)	■ (2)
273		● (2)	● (2)	■ (2)	■ (2)	■ (2)	■ (2)	■ (2)	■ (2)	■ (2)	■ (2)
279		● (2)	● (2)	■ (2)	■ (2)	■ (2)	■ (2)	■ (2)	■ (2)	■ (2)	■ (2)
305		● (2)	● (2)	■ (2)	■ (2)	■ (2)	■ (2)	■ (2)	■ (2)	■ (2)	■ (2)
318		● (2)	● (2)	■ (2)	■ (2)	■ (2)	■ (2)	■ (2)	■ (2)	■ (2)	■ (2)
324		● (2)	● (2)	■ (2)	■ (2)	■ (2)	■ (2)	■ (2)	■ (2)	■ (2)	■ (2)
356			● (2)	■ (2)	■ (2)	■ (2)	■ (2)	■ (2)	■ (2)	■ (2)	■ (2)
406			● (2)	■ (2)	■ (2)	■ (2)	■ (2)	■ (2)	■ (2)	■ (2)	■ (2)
456											
508											
558											
610											

(1 or 2) Applicable DOP Lambda Curve

42 Number indicates the Linear Metres per carton

Size is available to order

■ These sections come "split" and are packed as single lengths which are shrink wrapped in polyethylene

Size currently not available

● These sections come "unsplit" and are packed as single lengths which are shrink wrapped in polyethylene

Alternative sizes may be available. For further details please contact ROCKWOOL Customer Support



FirePro DuctRock Slab

Fire protection for ventilation, smoke extract and kitchen extract ducts.



Tested to both BS EN 1366:Part 1 and BS EN 1366:Part 8 FirePro DuctRock Slab is capable of providing up to 2 hours fire resistance to rectangular ventilation and smoke extract ductwork.

The black foil surface provides a robust high-performance finish whilst making it easy to differentiate from our traditional Fire Duct System.

FirePro DuctRock Slab is manufactured with high density, non-combustible stone wool insulation and finished with a high emissivity black foil facing. Available in three thicknesses DuctRock Slab is easy to handle, simple to install and capable of achieving fire resistance of up to EI 120.

FirePro Glue and a high performance Black Aluminium Foil Tape are also readily available from ROCKWOOL for sealing all board joints.

- EI 120 mins on ventilation and smoke
- Tested on both vertical and horizontal ducts
- Wide ranging scope for many duct types
- High quality black foil finish
- Patented horizontal penetration detail

APPLICATIONS

DuctRock Slab has been designed for use with rectangular and square steel ductwork systems and has been fire tested in conjunction with the following duct types shown in table 1.

Table 1

Ventilation Duct: Type A		Ventilation Duct: Type B		Smoke Extract Duct: Type C
Horizontal	Vertical	Horizontal	Vertical	
✓	✓	✓	✓	✓

PERFORMANCE

Fire performance

FirePro DuctRock Slab can achieve fire resistance ratings; Integrity (E) and Insulation (I) of EI 30 to EI 120 with only 3 thicknesses. Table 2 provides a summary of fire performance.

Table 2

FirePro DuctRock Slab (mm)	Ventilation Duct: Type A		Ventilation Duct: Type B		Smoke Extract Duct: Type C	Ducts with a Combustible Lining
	Horizontal	Vertical	Horizontal	Vertical		
*60	EI 60	EI 60	EI 60	EI 60	EI 60	N/A
80	EI 90	EI 90	EI 90	EI 90	EI 90	N/A
90	EI 120	EI 120	EI 120	EI 120	EI 120	**EI 60

*Use 60mm FirePro DuctRock Slab for EI 30 fire ratings

**DuctRock slab has been tested in accordance with the criteria set out in section 11.2.2 of BS EN 1366-1:2014 (Ducts with combustible lining) where additional thermocouples were positioned within the duct to record the average and maximum temperature rise. Insulation failure was defined in accordance with EN 1363-1.

PRODUCT INFORMATION

Property	Description
Length	1200mm
Width	1000mm
Thickness	60, 80 & 90mm
Facing	Black aluminium foil
Fire resistance	Up to EI 120*

* Subject to the application

STANDARDS AND APPROVALS

Certificate
DuctRock Slab has been tested in accordance with BS EN 1366: Part 1 for ventilation ducts and also BS EN 1366: Part 8 for smoke extraction ducts achieving up to EI 120 minutes*.
DuctRock Slab has been classified in accordance with EN 13501-3:2005 +A1: 2009.
Fire Resistance Classification: up to EI 120 (ve, ho, i ↔ o) S
DuctRock has been classified in accordance with EN 13501-4:2016.
Fire Resistance Classification: up to EI 120 multi (ho/ve) S 500

* Subject to the application



INSTALLATION

FirePro DuctRock Slab can be rapidly installed onto rectangular and square steel ductwork using a combination of $\text{Ø}2.7 - \text{Ø}3.0\text{mm}$ stud welded pins, $\text{Ø}30\text{mm}$ steel washers and ROCKWOOL FirePro Glue. All board abutments and cross joints must be covered with ROCKWOOL black aluminium foil tape.

DuctRock Slab thickness (mm)	Stud welded pin length (mm)
60	62mm
80	82mm
90	92mm

FirePro DuctRock is easily cut with a hand saw or alternatively a circular/table saw. The top and bottom slabs should be cut 10mm wider than the width of the duct to ensure a tight cross joint with the side slabs. The side slabs should be cut to the height of the duct (H) + 2 x the insulation thickness as shown in Figure 1.

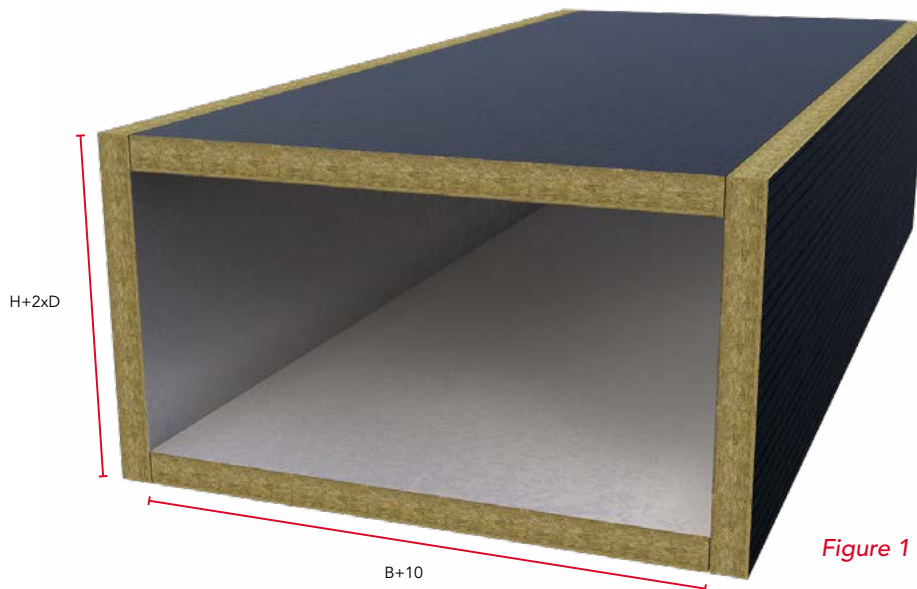


Figure 1

Top slab

When installed within horizontal applications the top boards do not require any stud welded pins and is simply positioned onto the duct with all board joints bonded with FirePro Glue. Board joints must be covered using ROCKWOOL black foil tape.

Side wall slabs

The side wall slabs are installed using stud welded pins with 350mm maximum centres along the length of the duct and 400mm centres across the depth as shown in Figure 2.

Side wall slabs must overlap the top and bottom boards as shown in Figures 3 & 4. All cross joints must be bonded with ROCKWOOL FirePro Glue.

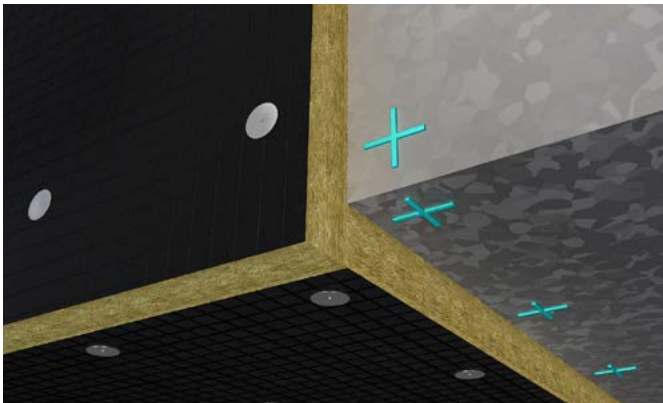
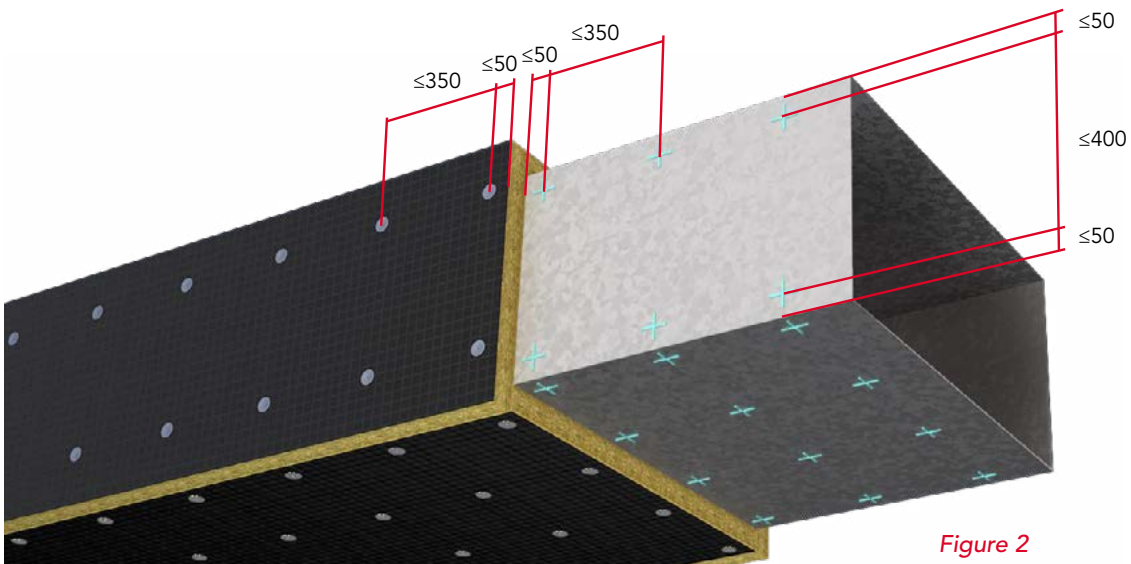


Figure 3
Cross joint horizontal duct

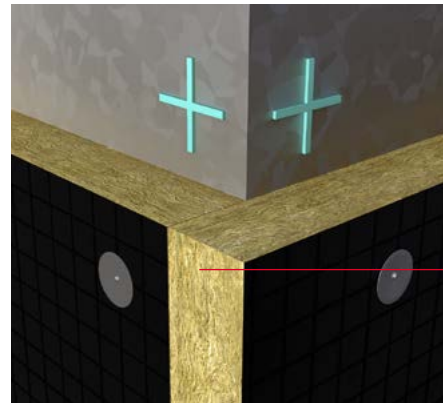


Figure 4
Cross joint vertical duct

Board edges must be covered with ROCKWOOL Black Foil Tape

Important: To ensure that there is a strong bond between the welded pin and the duct, always ensure that the welded pin is sufficiently isolated from the foil surface of the insulation during welding.



Base slab

Install the base slabs with stud welded pins at a maximum of 350mm centres along the length of the duct and 300mm centres across the width of horizontal ducts and 450mm across the width of vertical ducts as shown as shown in Figures 5 and 6.

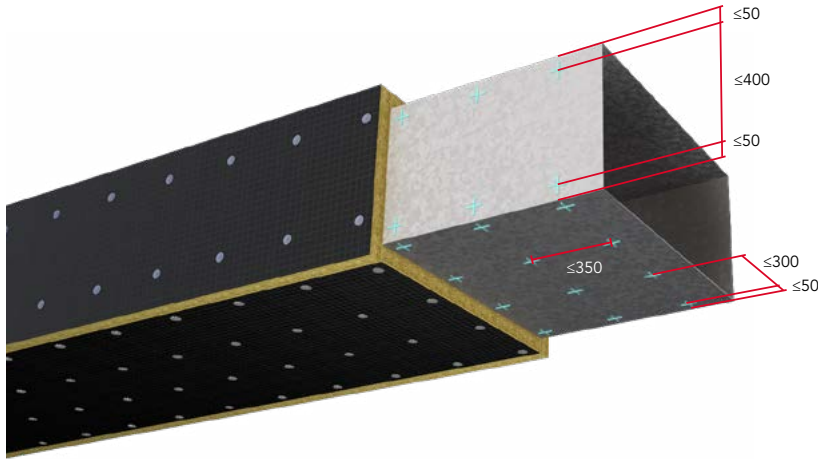


Figure 5
Horizontal duct

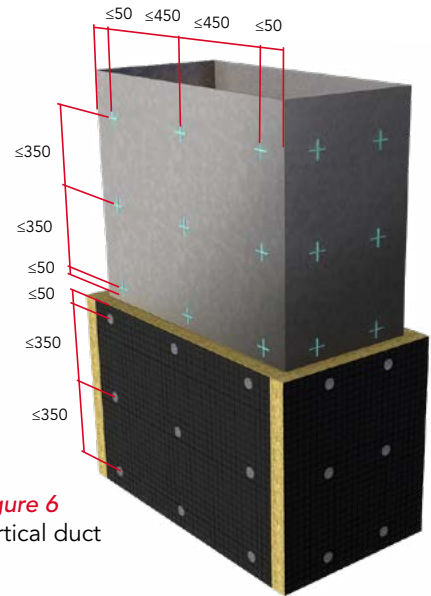


Figure 6
Vertical duct

Detailing around flanges and drop rod hangers

Where the DuctRock Slab bypasses a flange, drop rod hanger or both, cut a notch into the insulation as shown in Figure 7a-c. The insulation can easily be cut with a sharp knife or hand saw. All board joints must be bonded with FirePro Glue.

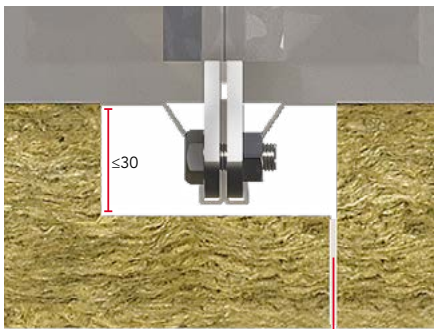


Figure 7a

Glue the joints with FirePro Glue

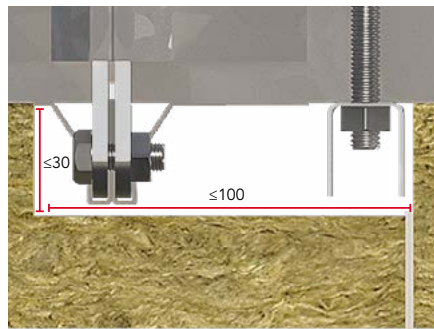


Figure 7b

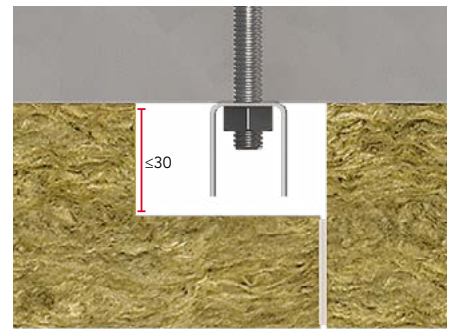


Figure 7c

Dry wall penetration

In order to maintain fire performance, provide stability and minimise noise transfer, ROCKWOOL have developed a patented solution for installing DuctRock Slab at the point where the duct penetrates a dry wall system.

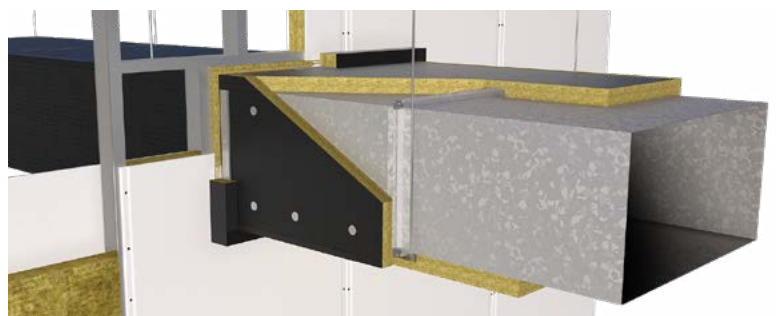


Figure 8
ROCKWOOL Patented Dry Wall Penetration Detail

Installation procedure: Dry wall Penetration

1. A joint in the DuctRock Slab must be accommodated at the centre point of the aperture, as shown in Figure 10.
2. Fill the remaining annular space between the DuctRock Slab and supporting structure of the dry wall system with ROCKWOOL RWA45 as shown in Figure 9.
3. To stiffen the duct around the penetration a 1.5mm thick steel u-profile (60 x 25 mm) must be fitted approx. 20mm from the wall, to both the vertical and horizontal sides of the duct (both sides of the aperture) the length of the profile can be determined using the following formula:

$$\text{Duct Width/Height} + (2 \times \text{Insulation Thickness}) - 50\text{mm}$$

Examples shown in table below:

Duct size (mm)	Insulation thickness (mm)	U-Profile length (mm)	
		Horizontal	Vertical
1500 (L) x 1000 (W) x 500 (H)	90	1130	630
1500 (L) x 1000 (W) x 250 (H)	90	1130	380

4. Before applying the u-profile to the DuctRock Slab slits must be cut into the insulation to allow the profile sides to penetrate the insulation (Figure 10). The u-profile can be attached to the ductwork using 100mm self-tapping screws. 4No to the top and bottom slabs and 2No to the vertical slabs.
5. Once the u-profiles have been applied an insulated collar must be installed around the perimeter of the aperture. The collar can be simply cut from the DuctRock Slab. Fix the collars in place with FirePro Glue as shown in Figure 9. Use nails to temporarily hold the collars in place whilst the glue cures.
6. ROCKWOOL Black foil tape can be used to cover any exposed edges of the collars.

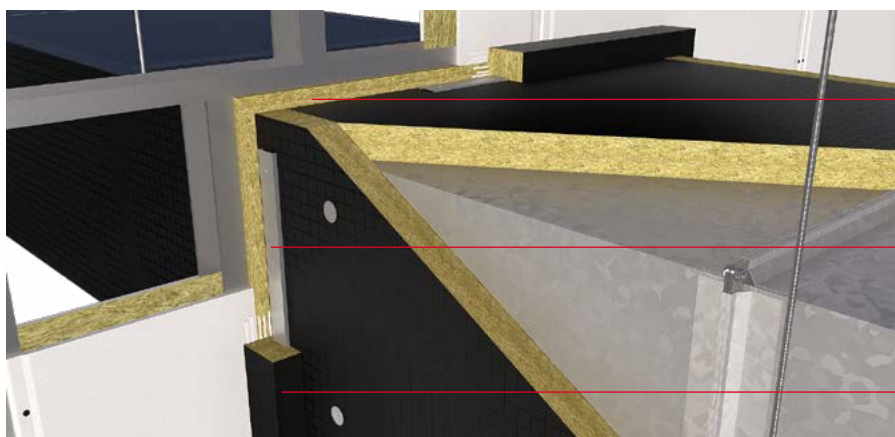


Figure 9

Annular space filled with ROCKWOOL RWA45

Steel u-profile fixed 20mm from the wall

60mm x 100mm DuctRock collars bonded to the substrate with FirePro Glue

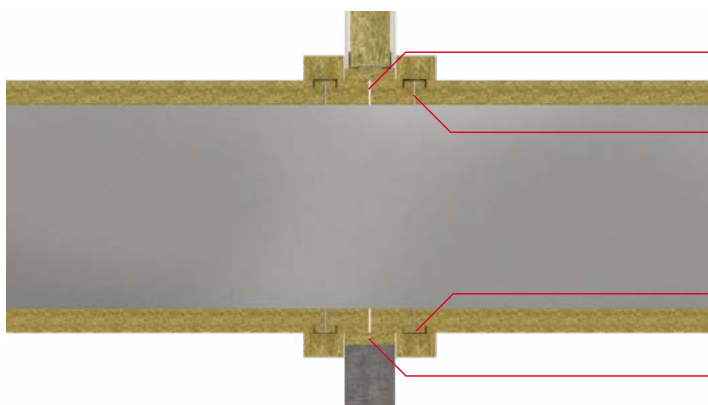


Figure 10

DuctRock joint at the centre of the aperture bonded with FirePro Glue

100mm self tapping screws

25mm (depth) slits cut into the DuctRock Slab to accommodate the legs of the u-profile

Annular space filled with ROCKWOOL RWA45



Installation procedure: Floor penetration

1. Maintain a 30mm gap between the ductwork and floor structure. Fill the gap between the duct and the floor structure with a ROCKWOOL Slab e.g. ROCKWOOL RWA45 as shown in Figure 11a. The flexible slab can be sealed within the void using FirePro Glue.
2. Secure the duct to the floor structure using 4 no. 50 x 50 x 45 x 2.5mm galvanised steel angles to both sides of the aperture. The angles can be fixed using 2No 3.2 x 25mm self-tapping screws. Alternatively, the duct can be secured with a 40 x 40 x 3mm L profile as shown in Figure 11b. The length of the L profile should be equal to the width of the duct and installed to both sides (duct width).
3. Apply a DuctRock collar to the perimeter of the aperture and on both sides as shown in Figure 11a. The collars can be fixed using FirePro Glue and temporarily held in place with nails until the glue cures.

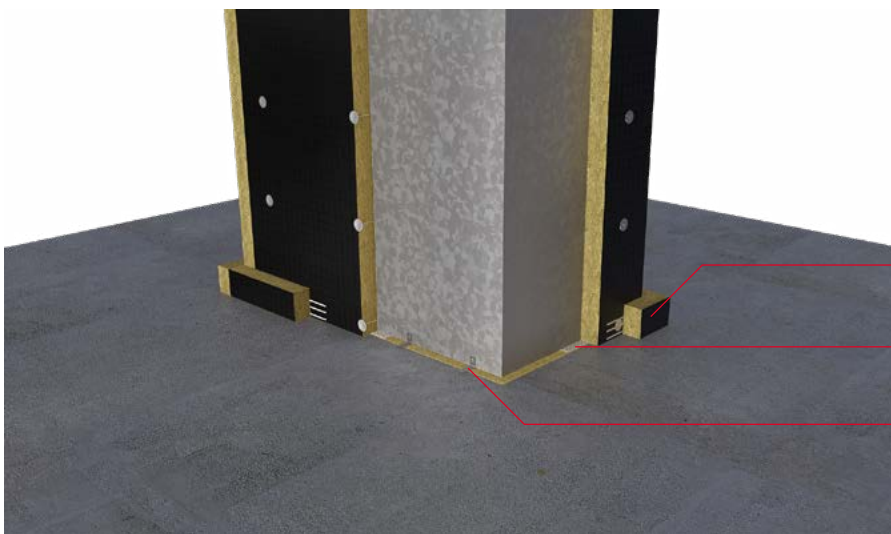


Figure 11a

60mm x 100mm DuctRock collars bonded with FirePro Glue

Seal the ROCKWOOL Slab within the aperture space with FirePro Glue

Secure the duct to the substrate using 4 no. 50 x 50 x 45 x 2.5mm galvanised steel angles fixed with 3.2 x 25mm self tapping screws

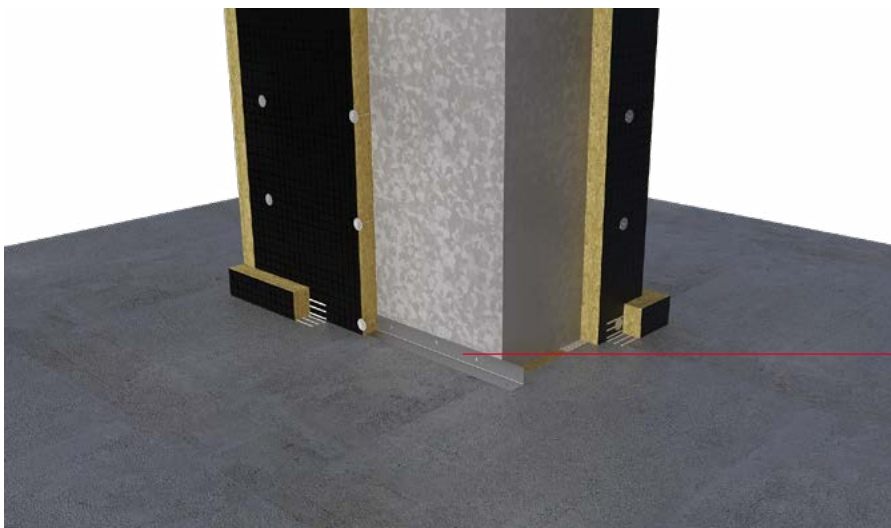


Figure 11b

40 x 40 x 3mm galvanised steel L-profile fixed with 3.2 x 15mm self tapping screws to the duct and 7.5 x 62mm screws to the floor.

Elbows

Elbows can be protected by cutting the DuctRock Slab into fan shaped segments as shown in Figure 12a. Alternatively v-shaped slits can be cut into the back of the DuctRock Slab allowing it to wrap around the elbow as shown in Figure 12b. Fill the v-shaped channels with FirePro Glue before applying to the duct and use nails to temporarily hold the insulation in place whilst the glue cures.

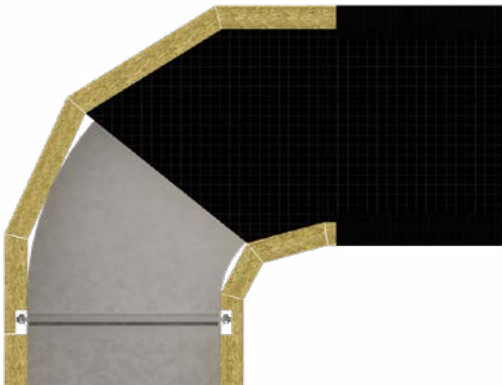


Figure 12a

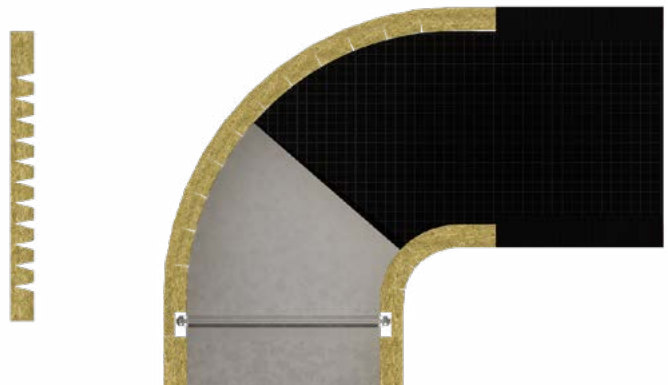
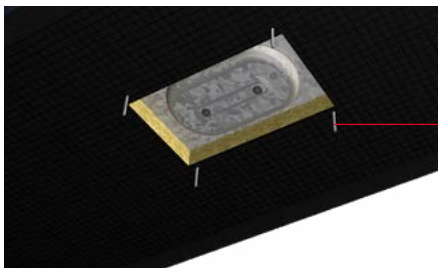


Figure 12b

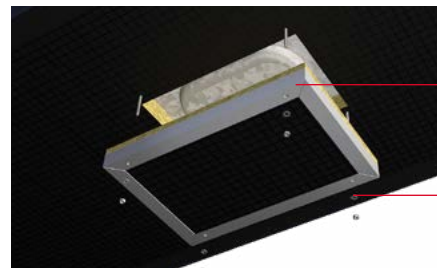
Access hatches

DuctRock Slab can be cut and positioned within a steel frame to form a removable cover in the location of the steel access hatch. The insulated cover can be attached to the duct using 4N° M8 threaded rods (Figure 13a) ensuring the rods are secured on both sides of the duct. The cover is then fixed to the rods using steel M8 nuts and washers. The thickness of insulation should be appropriate to the fire resistance required.



4 x M8 threaded rods secured to both sides of the duct.

Figure 13a



Steel frame for housing the removable insulated cover.

Removable cover secured to the threaded rods with M8 nuts and washers.

Figure 13b

Ancillaries

FirePro Glue and ROCKWOOL Black Foil Tape are available from ROCKWOOL stockists

Stud welded pins and self-tapping screws are available through CEVaC Limited, Tel: +44 (0) 1403 786503





SPECIFICATION CLAUSES

All ductwork is to be insulated with.....* mm ROCKWOOL FirePro DuctRock Slab, having a factory applied reinforced black aluminium foil to one face and tested in accordance with BS EN 1366: Part 1 and/or BS EN 1366:Part 8.

DuctRock Slab is to be fixed to the duct using 2.7 - 3.0 mm diameter welded steel pins and 30 mm spring steel washers in accordance with the ROCKWOOL Product Data Sheet 'FirePro DuctRock'.

All joints are to be filled with FirePro Glue and held tightly closed.

Installed to steel ductwork which complies with the following specification criteria:

Steel duct dimensions up to 1000x1250 (height x width) and 1500mm in length

With leakage class B in accordance with EN 1507. Further information on leakage classes can also be found in DW/144: Specification for Sheet Metal Ductwork low, medium and high pressure/velocity air systems.

With an under-pressure or over-pressure up to 500Pa

Steel flanges to be spot welded to the duct:

- Ventilation Duct - 20mm flange
- Smoke Extract Duct - 30mm flange

Flanges to be held together with either a 20mm flange joint profile (duct types A & B) or 30mm flange joint profile (duct type C). All flange joints to be sealed with sealing grease.

With stiffeners as follows:

- EI 120 – Ventilation Duct: 1 x Ø 15mm steel pipe in each duct segment
- EI 120 – Smoke Extract Duct: 2 x Ø 15mm steel pipe in each duct segment

Sealed with and appropriate duct sealant and 5 x 15mm EPDM tape

The duct suspension system complies with the following specification criteria:

Horizontal ducts:

Fire resistance	Max tensile stress of suspension device	Max shearing stress of screws	Max distance from suspension device to duct joint
EI 30	9 N/mm ²	15 N/mm ²	150mm
EI 60	9 N/mm ²	15 N/mm ²	150mm
EI 90	6 N/mm ²	10 N/mm ²	150mm
EI 120	6 N/mm ²	10 N/mm ²	150mm
EI 120 (Smoke Extract)	6 N/mm ²	10 N/mm ²	150mm

With distance between suspension devices not exceeding 1500mm

The lateral distance between the outer vertical surface of the steel duct and the centre line of the suspension rod shall not exceed 50mm

Vertical ducts:

With distance between supporting structures not exceeding 5m

Any duct penetrations comply with the following specification criteria:

Horizontal:

Penetrating in rigid wall constructions or flexible walls with a minimum thickness of:

- EI30 – 70mm
- EI 60 – 95mm
- EI 90 – 95mm
- EI 120 – 130mm

And with a fire resistance equal to or greater than the tested DuctRock slab thickness.

For horizontal penetrations, the gap between the DuctRock Slab and supporting structure will not exceed 20mm.

For horizontal penetrations U-profiles 1.5mm thick, with dimensions 60 x 25mm must be installed approximately 20mm from the wall and on both sides of the wall. The legs of the u-profiles are lowered into slits cut into DuctRock Slab and fixed to the duct by means of

Ø 4.8mm x 100mm for EI 30 & EI 120

self-tapping screws; 4 on the top and bottom profiles and 2 on the vertical profiles.

Vertical:

Penetrating rigid floor constructions with a minimum thickness of:

- EI 30 – 100mm
- EI 60 – 100mm
- EI 90 – 150mm
- EI 120 – 150mm

And with a fire resistance equal to or greater than the tested DuctRock Slab thickness.

For vertical penetrations the duct is to be stabilised using 4 no. 'L' galvanised steel angles of 50 x 50 x 45 x 2.5mm or a 40 x 40 x 3mm L profile which are fixed to the vertical steel duct and the supporting structure on both sides of the floor.

FirePro DuctRock Slab is associated with the following NBS specification clauses:

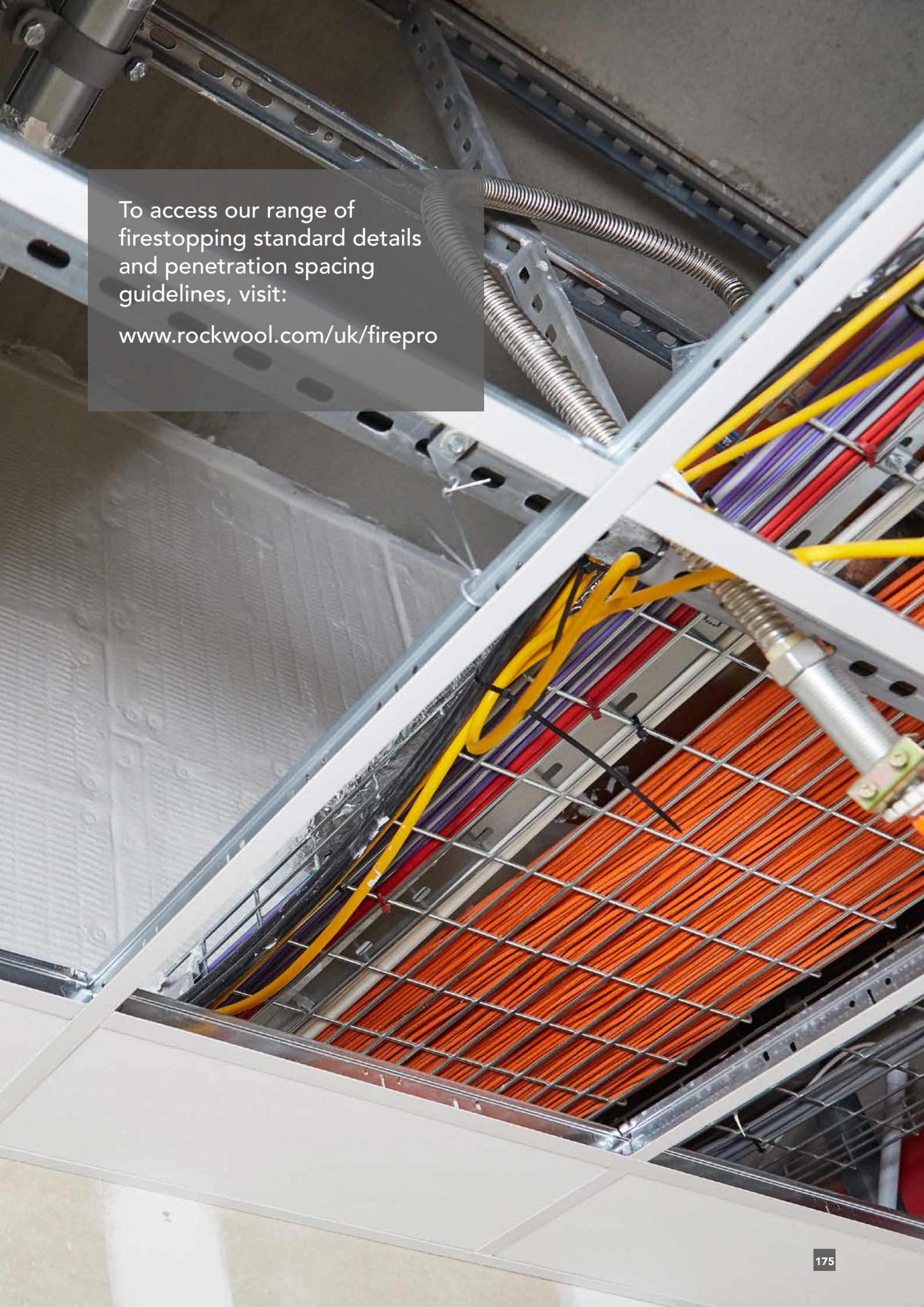
U90 General Ventilation – Domestic
490 Site applied insulation to ductwork
Y30 Mechanical Thermal Insulation
340 Mineral fibre slab insulation

ROCKWOOL

Firestopping Principles

1. ROCKWOOL will not support mixing fire protection of differing manufacturers systems/ products of any type in line with ASFP recommendations, unless proven by fire testing.
2. ROCKWOOL products should be installed in accordance with the relevant product data sheet and within the field of application identified on the standard details. For applications that fall outside the parameters identified in the standard details or data sheets please contact ROCKWOOL for further guidance.
3. Engineering Judgements are an appraisal of the likely performance of the installed ROCKWOOL products in that application when subjected to a fire resistance test. It is offered in lieu of direct formal testing and is based upon ROCKWOOL's experience of product performance during fire resistance testing. For this reason, before installation engineering judgements used on site should be reviewed and accepted by Building Control and / or the scheme Fire Office or the overseeing body for the project.
4. All penetrations within the dry lining system shall be framed and lined. a pattress fit option with ROCKWOOL Batts is available, but please check for its suitability.
5. Design of the penetration and its fire stopping should consider and correspond to the Integrity and Insulation requirements of the host wall or floor, unless leniency on the insulation rating is provided by the Fire Officer or overseeing body via a derogation.
6. Services of different types can pass through the same penetration, with the exception of ventilation (ducts and dampers) which should pass through exclusively through its own penetration, as per the EN test guidance.
7. Fire dampers and smoke dampers are to be independently supported from the soffit, therefore care should be taken where other services pass above the ventilation penetrations. Please refer to the damper manufacturers details and specification.
8. Support for services passing through walls should be within 500mm on each side. Services passing through floors should be supported at each level, as per industry and ASFP Guidance.
9. With reference to penetration spacings, please refer to the ROCKWOOL Spacing Guidelines Document





To access our range of
firestopping standard details
and penetration spacing
guidelines, visit:

www.rockwool.com/uk/firepro

LEGAL NOTICES

General safety requirements – Building Safety Act 2022

ROCKWOOL Limited is committed to supporting specifiers, resellers and users of ROCKWOOL products for the full life cycle of the product to comply with the obligations and responsibilities set out in the Building Safety Act 2022. With regard to the general safety requirements of the Act, ROCKWOOL Limited cannot control or foresee every situation where its products might be used. We therefore strongly advise that specifiers, resellers and users contact us where use of ROCKWOOL products is contemplated in applications different from those explicitly described in the latest, relevant ROCKWOOL product datasheets; especially in applications that can be reasonably foreseen as critical to safety.

ROCKWOOL Limited reserves the right to amend the specification of its products without notice. Changes to the ROCKWOOL manufacturing process, or to pertinent regulations, may be reflected in changes to tested and certified product performance. Whilst ROCKWOOL Limited endeavours to keep its publications up to date, readers will appreciate that between publications there may be pertinent changes in the law or other developments affecting the accuracy of the information contained in our publications.

ROCKWOOL Limited does not accept responsibility for the consequences of using (including testing or certifying) its products in applications different from those explicitly described in the relevant ROCKWOOL product datasheets. Expert advice should be sought, and ROCKWOOL Limited should be contacted, where such different use is contemplated, or where the extent of any use described by ROCKWOOL Limited is in doubt.

The ROCKWOOL Trademark

ROCKWOOL® - our trademark

The ROCKWOOL trademark was initially registered in Denmark as a logo mark back in 1936. In 1937, it was accompanied with a word mark registration; a registration which is now extended to more than 60 countries around the world.

The ROCKWOOL trademark is one of the most important assets of the ROCKWOOL Group, and is therefore well-protected and defended by ROCKWOOL throughout the world.

If you require permission to use the ROCKWOOL logo for your business, advertising or promotion, you must apply for a Trade Mark Usage Agreement.

To apply, write to:
marketcom@rockwool.com

Trademarks

Registered trademarks of the ROCKWOOL Group include but are not limited to:

ROCKWOOL®, RockClose®, RainScreen Duo Slab®, HardRock®, RockFloor®, Flexi®, RockFall®, FirePro®, DuctRock®, BeamClad®, NyRock®

© ROCKWOOL 2023.
All rights reserved.

Photography and illustrations

The product illustrations are the property of ROCKWOOL Limited and have been created for indicative purposes only.

Unless indicated below, the photography and illustrations used in this guide are the property of ROCKWOOL Limited. We reserve all rights to the usage of these images.

If you require permission to use ROCKWOOL images, you must apply for a Usage Agreement.

To apply, write to:
marketcom@rockwool.com

ROCKWOOL stone wool - safe to install and live alongside

There are no hazardous classifications associated with stone wool insulation manufactured by ROCKWOOL-UK according to EU REACH and UK REACH regulations on health and the environment.

ROCKWOOL safe use instruction sheets and material safety data sheets (where applicable) can be downloaded [here](#).



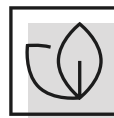
Sustainability

ROCKWOOL products are used to enrich modern living, creating safer, healthier and more climate-resilient communities.

We transform abundant, natural volcanic rock into stone wool insulation products that are used to reduce energy demand, lower fuel bills and help address society's climate change challenges.

ROCKWOOL stone wool insulation is recyclable and can be transformed into new ROCKWOOL products. Please contact us for details of how we can work together to recycle waste ROCKWOOL stone wool material that may be generated during on-site installation.

Our annual sustainability reports, which set out progress against our sustainability goals, and further details of the positive impacts of using our products can be found on our website.



Environment

ROCKWOOL takes a fact-based, auditable approach to documenting our progress in maximising our products' positive impact and minimising the effect our operations have on the environment, backed by third-party references and methodologies. Further details can be found online in our annual sustainability report.

Our high-tech production process uses filters, pre-heaters, after-burners and other cleaning and collection systems that help to reduce the effects of our manufacturing operations on the environment.

ROCKWOOL stone wool insulation does not contain (and has never contained) gases that have ozone depletion potential (ODP) or global warming potential (GWP).



February 2024

ROCKWOOL Limited

Pencoed
Bridgend
CF35 6NY

Tel: 01656 862 621

info@rockwool.co.uk

rockwool.com



3.03 February 2024

© ROCKWOOL 2024. All rights reserved.